

NAPCO

OPERATING AND INSTALLATION INSTRUCTIONS

**MAGNUM ALERT-850/850M
ALARM CONTROL CENTER
& DIGITAL COMMUNICATOR**



Table of Contents

<u>Section</u>	<u>Page</u>	<u>Section</u>	<u>Page</u>
1. INTRODUCTION.....	2	AMBUSH ZONE.....	13
GENERAL DESCRIPTION.....	2	KEYPAD PANIC.....	14
FEATURES.....	3	COMMUNICATOR-CONFIDENCE TEST.....	14
SPECIFICATIONS.....	5	FAULT FIND.....	14
ORDERING INFORMATION.....	6		
RECOMMENDED U.L.-LISTED DEVICES...7		4. PROM PROGRAMMING.....	15
U.L. CLASSIFICATIONS.....	8	PROGRAMMING MATERIALS.....	15
SUMMARY OF U.L. REQUIREMENTS.....8		PROGRAMMING STEPS.....	15
		PROGRAMMING RECORD SHEETS.....	17
2. CONTROLS & INDICATORS.....	9	GLOSSARY & PROGRAMMING DATA.....	19
REGULAR FUNCTIONS.....	9		
HOLD-DOWN FUNCTIONS.....	10	5. INSTALLATION.....	46
		MOUNTING.....	46
3. GETTING STARTED.....	12	GROUNDING.....	47
POWER-UP SEQUENCE.....	12	TAMPER SWITCHES.....	47
PERSONAL CODES.....	12	TYPICAL FIRE INSTALLATION.....	48
AC-FAILURE INDICATION.....	13	TESTING THE SYSTEM.....	48
ARMING & DISARMING THE SYSTEM...13		WIRING DIAGRAM.....	54

NOTE: COMPLETE KEYPAD INSTRUCTIONS INCLUDED IN THIS EDITION.

INDEX STARTS ON PAGE 51

(SEE PAGE 45 FOR A SUMMARY OF CHANGES FROM PREVIOUS EDITION)

U.L. Listed: MA-850 - Household Fire & Burglary Warning System Control Unit
MA-850M - Burglar Alarm System Control Unit (Grade A Local; Grade B Central Station; Grade A Police Station Connect)

(c) NAPCO 1986

WI341F 8/88

1. INTRODUCTION

GENERAL DESCRIPTION

The MAGNUM ALERT-850 and -850M are microcomputer-based eight-zone residential and mercantile (commercial) control panels, respectively, with provisions for Ambush, Panic, a Fire Zone and a variety of reporting features. Each system is contained within a wall-mounted enclosure and includes an integral digital communicator, an integrated siren driver, a multifunction digital keypad, a transformer, a battery, and a partially-programmed PROM (programmable read-only memory) integrated circuit.

The keypad allows the user to perform the following functions:

- * arm and disarm the system,
- * check the status of each zone,
- * check which zones were violated after an alarm,
- * temporarily shunt one or more zones,
- * cancel entry delay,
- * send a Panic or Ambush alarm,
- * enter or change arm/disarm codes,
- * test the audible alarm circuit,
- * test each zone for problems,
- * test the communicator while disarmed,
- * reset Ac-Failure indication,
- * bypass a Priority-with-Bypass Zone, and
- * turn the Door Chime feature on/off
- * enter a test-timer offset

Four LEDs, a digital readout and a sounder on the keypad provide visual and audible system and individual-zone status information. Most keys have secondary functions that are accessed by holding down the key until the sounder beeps, and are therefore termed "hold-down" functions. The following hold-down functions are provided:

- Key [1] - Alarm Test
- Key [2] - Display Shunted Zones
- Key [3] - Display Status
- Key [4] - Instant Alarm (cancels entry delay)
- Key [5] - Door Chime on/off
- Key [6] - Communicator Confidence Test
- Key [7] - Fault Find
- Key [8] - Program
- Key [9] - Reset (Ac-Fail Indication, Fire Zone, Output Relay Devices, and Fault-Find mode; Bypass Priority-with-Bypass)
- Key [S] - Alarm History (indicates last alarmed zone(s))

Each PROM is programmed for the particular installation to establish its specific alarm and reporting features.

FEATURES

Protection Zones

- * Eight end-of-line-resistor supervised zones.
- * Two separately-programmable entry delays for Exit/Entry Zones.
- * Burglary Zone options include:
 - Priority or Priority with Bypass
 - Selective or Group Shunting
 - 24-Hour Protection
 - Day Zone Supervision
 - Auto Reset
 - Exit/Entry Delay 1; Exit/Entry Delay 2
 - Preprogrammed Auto Shunt (removable)
 - Optional 50mS or 7mS Loop Response (normally 750mS)
 - Programmable Abort Delay

Alarm Outputs

- * Timed Burglary Output: Programmable by zone and time
- * Timed Relay Output: Programmable by zone and time
- * Timed Fire Output: Fixed to Fire Zone, programmable for time
- * Pulsing Bell Output: Fixed to Fire Zone, programmable for time

Keypad Functions

- * Keypad permits:
 - Arm/Disarm Code Selection of up to 4 user codes, up to 4 digits each
 - Digital Code Entry to arm/disarm system
 - Selective and Group Shunt Selection
 - Panic Zone Activation
 - Ambush Activation
 - Hold-Down Function Access
 - Resetting of various functions and conditions
- * LEDs display:
 - Alarm State (armed/disarmed) (ARMED/ALARM)
 - Zone Status (STATUS) - one or more zones in trouble
 - Zones Shunted (SHUNT) - one or more zones shunted
 - Fire Zone Status (FIRE/TROUBLE)
- * Digital Readout displays:
 - Zone(s) in alarm and alarm history
 - Zone(s) in trouble
 - Zone(s) shunted
- * Keypad Sounder indicates:
 - Entry Delay in Progress
 - Hold-Down Function Accessed
 - Entry Door Opened while Disarmed (Door Chime)
 - System Armed with a Zone in Trouble
 - Day Zone in Trouble
 - Fire Zone Alarm/Trouble
 - Central-Station Ringback

Communicator Features

- * Integral digital communicator with true dial-tone detection, double-pole line seizure and anti-jam.
- * Programmable abort delay time.
- * Rotary or Touch-Tone dialing available. Rotary dialing available as backup to unsuccessful Touch-Tone dialing.
- * Two telephone numbers and receiver/data formats can be accessed. A single master PROM is compatible with all popular receivers.
- * Two-digit event codes and 4-digit subscriber codes programmable for those receivers accepting these formats.
- * Central-Station Ringback.

Reporting Features

- * Report on Alarm
- * Opening and/or Closing Reporting by Individual User
- * Opening Report After Alarm
- * Day Zone Trouble; Fire Zone Trouble
- * Ambush; Panic
- * Test Timer; Restart Test Timer on Any Report
- * Ac Failure; Low-Battery Report
- * Conditional-Closing Report; Conditional-Closing/Status Report
- * Control-Center Restoral Report; Zone Restoral Report
- * Backup Reporting; Double Reporting; Split Reporting

Other Features

- * Audible Bell-Test on Arming
- * Come Up Armed After (extended) Power Failure
- * Programmable Door-Chime Duration

NOTE: The factory-programmed portion of the PROM constitutes proprietary information of NAPCO and is protected by copyright law. Unauthorized use of the PROM in other than NAPCO products is prohibited.

SPECIFICATIONS

Operating Temperature:	0-49 degrees C (32-120 degrees F)
Input Power:	16Vac, Class 2 step-down transformer MA-850, 14.4VA (TRF-8) MA-850M, 20VA (TRF-9)
Loop Voltage:	10 to 13Vdc
Loop Current:	5.5mA (normal resistance)
Loop Resistance:	300 ohms maximum series resistance/loop 200 ohms on Fire Zone without FT-279
Alarm Outputs	
Siren/Bell Output:	(Selectable for speaker or bell) Siren - 15W, 8 ohms; 30W, 4 ohms Bell - 12Vdc, 1.2A maximum
Relay Output (on alarm):	12Vdc regulated, 1.0A maximum when Lug E14 is used.
Contact Ratings:	24Vdc, 2A (resistive)
Auxiliary Output:	12Vdc regulated
Combined Standby Current:	Remote Power, Aux. Out, Relay Out (Standby or Alarm), maximum, MA-850, 250mA with standard TRF-8 & RBAT-4 400mA with optional TRF-9 & RBAT-6 MA-850M, 400mA with standard TRF-9 & RBAT-6
Remote Station	
Current:	50mA
Sounder:	10mA
Battery:	Rechargeable, sealed lead-acid MA-850, RBAT4 (12Vdc, 4AH) MA-850M, RBAT6 (12Vdc, 6AH)
Standby Time:	4 hours minimum (8 hours with 2 batteries)
Fuses	
Siren Driver:	4A, 1AG (F1)
Aux. Power/Relay Output:	3A, 1AG (F2)
Remote Power:	1A, 1AG (F3)
Speaker/Bell:	3A, 1AG (F101)
Housing Dimensions:	MA-850, 12.6x12.6x3.6" (31.8x31.8x9.1cm) (HWD) MA-850M, 13.3x13.3x3.9" (33.8x33.8x9.9cm) (HWD)
Shipping Weight (Approx.):	MA-850, 15lb (6.8kg); MA-850M, 16-3/4lb (7.6kg)
<u>For Canadian Use Only:</u>	
Load Number:*	6
CSA-Approved Power Supply:	Magnetic Coil Transformer Model PG1620-D4 or MG1620-D2

*The "Load Number" denotes the percentage of the total load allowed to be connected to a telephone loop that is used by the device. The termination on a loop may consist of any combination of devices subject only to the requirement that the total of the Load Numbers of all devices does not exceed 100.

ORDERING INFORMATION - Starred items (*) are U.L.-Listed Accessories

MA-850 Residential 8-zone, 12-volt alarm control panel with integral communicator and siren driver; white keypad (1); TRF-8 transformer (1); DD495A PROM (1); and RBAT4 battery (1)

MA-850M Mercantile (commercial) alarm control panel as above except with larger, heavy-duty enclosure; white keypad (1); TRF-9 transformer (1); DD495A PROM (1); RBAT6 battery (1); and tamper switch (1)

RP1009* Remote Arming Station with dual-function keypad; LED, RP1009B* digital-display, and keypad sounder indication; panic RP1009I* and shunt. White is standard; RP1009B is brown; RP-1009I (white only) is illuminated.

RPB-1 Surface Mounting Backplate for RP-1009

RPB-2 Double-Gang Box for RP-1009

TPS-2 Tamper Switches (set of 2) (U.L. Listed)

RBAT4 Rechargeable Battery, 12Vdc, 4AH (MA-850)

RBAT6 Rechargeable Battery, 12Vdc, 6AH (MA-850M)

RBAT-H1* Dual Battery Harness

TRF-8 Transformer, 16Vac, 14.4VA, Class 2

TRF-9 Transformer, 16Vac, 20VA, Class 2 (U.L. Listed)

DH-1* Diode Harness

FT-279* End-of-Line Relay/Resistor Supervisory Module

GSM-400 Ground-Start Module

M278* Line-Reversal Module

SNP-428 Mini-Sounder

OI103 MAGNUM ALERT-850 Operating Guide

OI103QG Quick Guide

PF153A Programming Record Sheets, 100/pad

PRO-410/410M PROM Programmer

DD495A Partially-Programmed PROM

DD493BNK Blank PROM

TM-900* Timer Module

LW-850A Long-Range Wireless Interface

LW-900* Long-Range Wireless Interface (relay output)

A221 Consumer Brochure, Residential

A239 Consumer Brochure, Residential (in French)

A221COM Consumer Brochure, Commercial

A239COM Consumer Brochure, Commercial (in French)

SDC/850 Salesman's Demo Case

WD/850 Wall Demonstrator

***** NEW FEATURES *****

This edition includes the new features contained in Version "A" of the MA-850 and MA-850M panels. Version "A" uses a DD495A PROM and may be identified by label LA640 affixed to the micro shield on the printed circuit board.

Following are the key new features of Version "A".

- **DISABLE SWINGER SHUTDOWN** - Disables swinger shutdown on all zones. See glossary: **Disable Swinger Shutdown**.
- **TEST-TIMER OFFSET** - Locations 248 and 249 in PROM page 1 provide for offsetting the timer reporting time. Refer to **Test-Timer Offset and Time Selection** in the glossary.
- **KEYPAD TIMER OFFSET** - Test-timer offsets may also be entered at the keypad (see **Test-Timer Offset - Keypad Timer Offset** in the glossary).
- **LW-850A INTERFACE** - Connector for optional LW-850A Interface, which provides 24 outputs. Refer to the instructions furnished with the LW-850A.
- **DIAL "*" - A "*" may now be used in the telephone number.** This is useful for those systems that require a "*70" to disable Call Waiting. See glossary: **Disable Call Waiting**.

RECOMMENDED U.L.-LISTED DEVICES

Bells: Ademco AD8-12, AD10-12
Amseco MBL-8/12V, -10/12V;

Grade-A Bell: Ademco AB-12, Bell in Box

Speakers: Ademco 713
Atlas Sound VT-158U

Smoke Detectors: (MA-850 Residential Units Only)
BRK 1812*
2812TH*
Pyrotector 3212A/C/AT/CT with B92 base**
Pyrotector 7212A/C/AT/CT with B92 base**

- * 2 maximum; 4 maximum with TRF-9 and RBAT-6
- ** 8 maximum; 16 maximum with TRF-9 and RBAT-6

NOTE: The MA-850/M may not be used for fire protection where prohibited by local codes.

U.L. CLASSIFICATIONS

Household Fire & Burglary Warning System Control Unit (MA-850): Combination Fire and Burglary. See RECOMMENDED U.L.-LISTED DEVICES for compatible bells, speakers and smoke detectors.

Burglar Alarm System Control Unit (MA-850M): Grade-A Local Mercantile Premises Control Unit. Integral digital burglar alarm communicator transmitter suitable for Grade-C Central Station, or Grade-B Central Station when connected to a Grade-A bell; Grade-A Police Station Connect Mercantile Premises Control Unit when used with M-278 Line-Reversal Module. See ORDERING INFORMATION.

SUMMARY OF U.L. REQUIREMENTS

The following summarizes U.L. programming and wiring requirements for various types of burglar alarm control units.

Household Fire and Burglary: FT-279 End-of-Line Relay for Fire; Alarm Time-Out of 4 minutes minimum; maximum exit time of 60 seconds; maximum entry time of 45 seconds.

Grade-A Local: Low-battery alarm with DH-1 Harness (unless reporting low battery; supervised ground; door tamper; Grade-A bell; Audible Test On Arming; Alarm Time-Out of 15 minutes with Auto-Reset Zones, or 30 minutes without Auto-Reset; maximum exit and entry delays of 60 seconds.

Program Tamper Zone for: 24-Hour Protection (or Day Zone); Priority (or Remove Auto-Shunt); Burglary Output or Output-1 Relay (to activate bell).

Grade-B Central Station: Same as Grade-A Local except that low-battery reporting, Report On Alarm (all Burglary Zones including Tamper), and the TM-900 Timer Module are required.

Grade-C Central Station: Same as Grade B except that the bell is not required.

Grade-A Police Connect: Same as Grade-A Local except that the M-278 Line-Reversal Module is used for direct-connect signalling. Burglary Zones are programmed to activate a relay output that controls the M-278 Line-Reversal Module. The DH-1 Harness must be used to connect Low Battery to a zone. Digital communication is not required. See Wiring to a Grade-A Bell.

Grade-A or Grade-B Central Station (with Ademco 7600 Long-Range Wireless equipment): See instructions furnished with NAPCO LW-900 accessory. In mercantile installations not requiring a Grade-A bell, or if the Grade-A bell is activated by the relay output, speakers may be used as supplementary sounding devices (see RECOMMENDED U.L.-LISTED DEVICES).

2. CONTROLS & INDICATORS

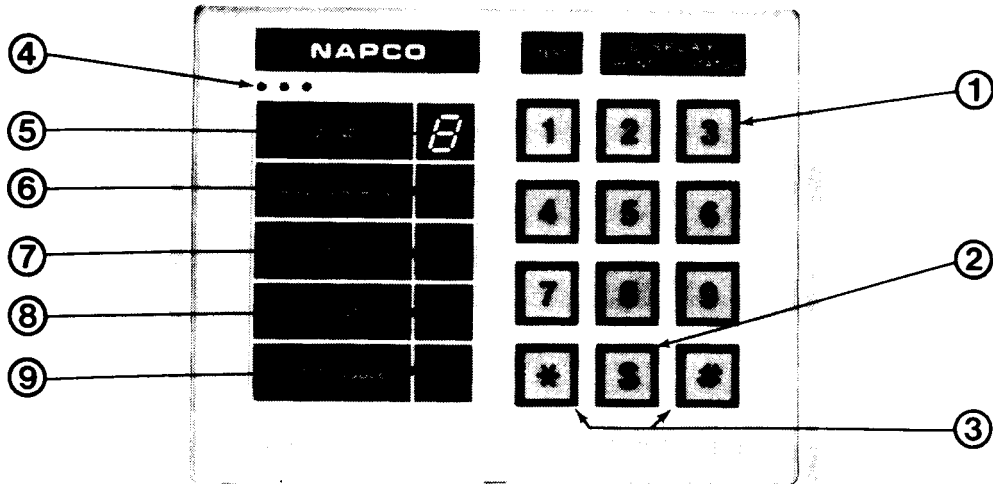

RP-1009 Keypad

NOTE: Circled numbers below are keyed to those in the photo above.

REGULAR FUNCTIONS

① Numerical Keys [1] through [9]. Used to enter arm/disarm code(s) and to select zones to be shunted. Also have special Hold-Down Functions as described in **HOLD-DOWN FUNCTIONS**.

② Shunt Key [S]. Used to select zones to be shunted. Also has a special Hold-Down Function as described in **HOLD-DOWN FUNCTIONS**.

③ Panic Buttons [*] and [*]. Signal an immediate emergency when *both* buttons are pressed at the same time.

④ Sounder. Sounds an audible tone at the keypad:

- A continuous beep upon entry alerts that the entry-delay period is in progress (disarm to silence).
- A beep while disarmed indicates that someone has activated the door-chime feature (Zone 1).
- A pulsing beep with digital display while disarmed signifies a Day-Zone trouble.
- A momentary beep when a key is depressed indicates that a Hold-Down Function has been accessed.
- A 2-second beep signals that a zone in trouble has been auto-shunted (does not apply to selective- or group-shunted zones); a 24-Hour Zone is latched in a trouble condition; or a low-battery condition exists. (Hold down Key [3] to check zones.) In the Fault-Find mode, a zone in trouble has been repaired.

- A 3-second beep shortly after arming (about 15 seconds to a minute, or so) indicates a central-station ringback if a closing report is programmed.
- A pulsing beep with FIRE/TROUBLE LED indicates a fire alarm/trouble condition.

⑤ Digital Readout. Displays zone(s) in trouble, zone(s) shunted or zone(s) violated (Alarm History) when respective hold-down function is accessed. Displays "0" (with steady sounder tone) if an attempt is made to arm with a priority condition, or if a Day Zone trouble or ac-failure indication is not reset.

⑥ Top Red ARMED/ALARM LED. Glows steadily to indicate that the system is armed. A flashing LED when armed warns that a non-24-Hour Zone was in an alarm condition (the violated zone(s) will be displayed on the digital readout), or that the system is armed with Instant Protection (Hold-Down Function 4).

⑦ Green STATUS LED. Glows steadily to indicate that all zones that are not shunted are operating properly and the system may be safely armed. A flashing LED warns that one or more zones is in trouble. (The troubled zone(s) are displayed on the digital readout when the Display Status hold-down feature, Key [3], is depressed for about 2 seconds.)

⑧ Yellow SHUNT LED. Glows steadily to indicate that one or more zones has been manually shunted, and that the system is only partially armed. (The shunted zones are displayed on the digital readout when the Display Shunt hold-down feature, Key [2], is depressed for about 2 seconds.)

⑥⑦⑧ All three LEDs flashing together indicates an ac power failure. The control panel may be armed while powered by the standby battery as follows: (1) Hold down Test function Key [1] to test the battery/alarm. After battery operation is confirmed, (2) hold down Reset function Key [9] until it beeps to reset the flashing LEDs, then (3) enter the arming code (otherwise a "0" will appear on the display and the panel will not arm).

⑨ Bottom Red FIRE/TROUBLE LED. Flashes to indicate that the Fire Zone is in trouble; glows steadily to indicate an alarm.

HOLD-DOWN FUNCTIONS

In addition to its regular functions, the digital keypad provides a set of dual functions. Note that these functions are accessed by holding down the designated key for about 2 seconds (until the sounder beeps) and are thus referred to as *Hold-Down* functions.

Key [1] - Test. Momentarily sounds the burglar alarm. Instruct the user to make this test weekly.

Key [2] - Display SHUNT. Displays the zone(s) shunted on the digital readout. While holding down Key [2], note the number(s) displayed indicating the zone(s) shunted.

Key [3] - Display STATUS. Displays the zone(s) in trouble on the digital readout. While holding down Key [3], note the number(s) displayed indicating the zone(s) in trouble.

Key [4] - Instant Protection. Cancels the entry delay period(s). This is used to sound an instant alarm on intrusion through the Exit/Entry Zone(s). When selected, the ARMED/ALARM LED will flash rapidly to indicate that entry delay has been cancelled. Entry delay is automatically reinstated on disarming.

Key [5] - Door-Chime Off/On. The Door-Chime feature functions on Zone 1 only. If Zone 1 is selected as the regular entry door (it need not be a delayed zone), the sounder will beep upon entry while disarmed. To enable the Door-Chime feature, hold down Key [5] until it beeps. The duration of the beep is programmable.

Key [6] - Communicator-Confidence Test (Optional). Checks the telephone line for the presence of a dial tone (applies only to those systems programmed to communicate with a central station).

Key [7] - Fault Find (Optional). Sets all zones for the fastest loop response (7mS) while disarmed; also, causes the sounder to beep for 2 seconds when a zone in trouble is cleared. This feature aids the installer in locating "swingers" and assists the user in repairing zone troubles. Normal operation may be restored by holding down Reset Key [9].

Key [8] - Program. After the Program Code is entered, the Program Mode is accessed for the purpose of entering, changing, or voiding personal arm/disarm codes. See **Loading Personal Codes.**

Key [9] - Reset. Functions as a general-purpose reset to

- reset Fire Zone alarm/trouble indication;
- reset Ac-Failure indication (top three LEDs blinking);
- reset a Day-Zone indication (sounder and display);
- reset output-relay devices;
- reset the Fault-Find mode;
- bypass a troubled zone designated as a Priority-with-Bypass Zone. See **Priority Zone With Bypass** in the glossary.

Key [S] - Alarm History. This will display (on the digital readout) all alarm conditions that have occurred. While holding down Key [S], note the number(s) displayed indicating the zone(s) violated. After the system is rearmed, the previous alarm history will remain memorized unless automatically erased by a new alarm.

3. GETTING STARTED

POWER-UP SEQUENCE

1. *Before applying power*, plug the PROM into the socket on the circuit board.
2. Connect ac power.
3. Install the RBAT4 (MA-850) or RBAT6 (MA-850M) battery (supplied).
4. Connect a CC403 telephone cord to the RJ31X jack.

PERSONAL CODES

Loading Personal Codes

Up to four different personal arm/disarm codes may be entered into the control panel using the keypad. Hold down Key [8] until the sounder beeps, then enter the Program Code (programmed in the PROM). After the Program Code has been entered, the top three LEDs on the keypad will flash and the sounder will beep rapidly, indicating access to the Program Mode. Now enter up to four codes using any combination of up to four digits (numbers 1 through 9) as follows:

Press [S] then [1] then [any 4 digits] = first user's code
[S] then [2] then [any 4 digits] = second user's code
[S] then [3] then [any 4 digits] = third user's code
[S] then [4] then [any 4 digits] = fourth user's code

After all codes have been entered, press [S] *twice* to exit the Program Mode.

NOTE: It is not necessary to assign all four codes.

The numbers selected become the only codes recognized by the system. Each user should be assigned his own dissimilar code and should be cautioned against divulging that code to anyone else. Thus, should it become necessary to remove a user from the system, that one code may be voided without affecting other codes, and that user would then be prevented from entry.

Changing or Voiding a Code

Changing any user's code is accomplished using the foregoing procedure and simply changing the 4-digit combination. Thus, to change User 3's code:

1. Hold down Key [8] until the sounder beeps.
2. Enter the Program Code (LEDs flash; sounder beeps).
3. Press [S] then [3] then [4 new digits] = User 3's new code.
4. Press [S] *twice*.

Similarly, User 3's code may be voided by not entering a 4-digit combination. Thus, to void User 3's code:

1. Hold down Key [8] until the sounder beeps.
2. Enter the Program Code (LEDs flash; sounder beeps).
3. Press [S] then [3] = User 3's code erased.
4. Press [S] *twice*.

AC-FAILURE INDICATION

Loss of ac power is indicated by the top three LEDs flashing simultaneously. Hold-down function Key [9] will temporarily reset the LEDs in order to check zone status and to arm the system.

ARMING & DISARMING THE SYSTEM

When a personal code is entered into the keypad, the red ARMED/ALARM LED will either come on, indicating that the control panel is armed; or go off, indicating that the control panel is disarmed. If a wrong code is entered, the system will fail to respond. *Wait at least 2 seconds* before attempting to re-enter a code.

Fallback Code. If the system fails to respond to a correct code, as may occur after an extended power failure, all personal codes have been erased and the preprogrammed Fallback Code must be utilized to arm and disarm. See **Fallback Code** in the glossary. Note that the Fallback Code will not work if any personal code is programmed.

Alarm Reset. Disarm the control panel to silence a sounding device. If the panel is already disarmed and an alarm sounds on a 24-Hour Zone, first arm, then disarm to silence the device.

AMBUSH ZONE

The Ambush Zone may be accessed by the user by entering his Ambush Code just prior to disarming. Thus, should he be forced to disarm by an assailant, the user can silently signal an emergency while appearing to be merely disarming the system. The arm/disarm personal code must be entered less than 10 seconds after the Ambush Code for an ambush report to be transmitted. The Ambush Zone is a "report-only" zone.

KEYPAD PANIC

The Keypad Panic Zone is accessed by simultaneously pressing the two Panic Buttons (Keys [*] and [#] on the keypad), or remote panic buttons wired to the keypad, and may be programmed to send a silent alarm to a central station, activate an audible alarm, or both. Note that the [*] and [#] keys must be pressed at the same time to activate Keypad Panic. Also see Panic Zone in the glossary.

COMMUNICATOR-CONFIDENCE TEST

This feature checks the telephone line for the presence of a dial tone only in those systems that are programmed to communicate with a central station.

Hold down Key [6] until the sounder starts to beep. If the line is okay, the beeping will stop, otherwise a steady tone will sound (check phone lines). To silence the sounder, hold down Reset Key [9].

FAULT FIND

When the Fault-Find mode is accessed (Key [7]), two things occur:

- a. the loop response of all zones is preset to 7mS (fastest loop response), and
- b. clearing a zone in trouble causes the sounder to beep for about 2 seconds.

This set of conditions aids both installer and user. The installer, tapping and poking at suspect points, can easily locate swingers by listening for the beep. Similarly, the user can confirm the repair of a zone in trouble by listening for the beep, and thus eliminate the need of returning to the keypad to visually check after each attempt.

Hold down Reset Key [9] to restore normal operation. Arming the system automatically cancels the Fault-Find mode.

For complete details of operation, refer to the MAGNUM ALERT-850 Operating Guide, OI103.

4. PROM PROGRAMMING

PROGRAMMING MATERIALS

Subscriber PROM. The partially-programmed DD495A PROM (integrated-circuit) supplied with the control panel becomes a subscriber PROM when programmed with the selected features and communicator information required for the installation. The PROM is programmed on a NAPCO PRO-410/410M Programmer. After programming, the subscriber PROM is plugged into the PROM socket on the control-panel circuit board.

Glossary. Detailed programming instructions are contained in the **GLOSSARY & PROGRAMMING DATA** section of this manual. Glossary entries are listed in alphanumeric order, not in order of PROM location; PROM locations follow entry where applicable.

Programming Record Sheets. Programming Record Sheets (PF153A) similar to those which follow are completed when planning system features and communicator information for the particular installation. These sheets are used when programming the subscriber PROM, and should be retained for future reference.

PROGRAMMING STEPS

1. Contact the central station to confirm receiver format, data format, event codes, subscriber numbers and telephone number(s). Two receiver descriptions and telephone numbers, and up to 4 Subscriber Identification Numbers may be required.

2. Complete the Programming Record Sheet. Reference record sheets for the MA-850/850M are furnished in the following pages. Select the desired features by circling the respective "location" boxes. Refer to the **GLOSSARY** for guidance in selecting "data" entries.

3. To program the subscriber PROM, follow the instructions furnished with the PRO-410/410M Programmer. Note, however, the PAGE switch on the Programmer. Factory-programmed data are contained on PROM Page 1, programmable data on Page 0; thus the PAGE switch is normally set to [0]. The PAGE 1 position is used only to alter factory-programmed data in order to accommodate special applications. It is not necessary to copy a NAPCO Master PROM onto the DD495A PROM supplied with the system. The DD495A PROM already contains the master information preprogrammed into it. Plug the partially-programmed DD495A PROM into the Programmer [SUBSCRIBER] PROM socket.

CAUTION: Before attempting to alter preprogrammed data on Page 1, be sure that all Page-0 data in memory are erased (press [ERASE], then [EXECUTE]). Except for the Page-1 location being programmed, there should be nothing in memory. After programming Page 1,

return the PAGE switch to [0] and clear the memory to continue programming.

4. Program the data entries in the boxes on the Programming Record Sheets into the respective PROM locations. The Programmer digitally displays the entries, but will display "0" for the number "10", and letters "b", "C", "d", "E", and "F" for the numbers "11" through "15", respectively. To program a "10", press [0]. To program "11" through "15", either press [b] through [F] respectively, or use the [PLUS] key to enter any two (or more) digits that add up to the desired entry.

Entry Total:	10	11	12	13	14	15
Display:	0	b	C	d	E	F

Thus, to program "13", enter either [d] or [8] [PLUS] [5], or [8] [PLUS] [4] [PLUS] [1], etc. Similarly, to add to an existing PROM location, first press the [PLUS] key, then the complementary digit, otherwise the digit entered will replace the digit in memory.

Refer to the PRO-410/410M instruction booklet for further programming details.

5. Complete the PROGRAMMED ZONE FEATURES section of the supplied INSTALLATION RECORD label (reproduced below). Peel off the adhesive covering and affix the label to the lower-left corner inside the control-panel door. This summary will be used by the installer to match wiring options to programmed features.



NAPCO PRO-410 Programmer

ZONE		AREA PROTECTED	ZONE DEVICES
1			
2			
3			
4			
5			
6			
7			
8			

SPECIAL NOTES _____



ALARM TIME		PROGRAMMED ZONE FEATURES											
BURGLARY =	___ Min.	Zone 1	Zone 2	Zone 3	Zone 4	Zone 5	Zone 6	Zone 7	Zone 8	Zone 9	Zone 10	Zone 11	Zone 12
FIRE (supv.) =	___ Min.	Priority With Bypass	Zone 1	Zone 2	Zone 3	Zone 4	Zone 5	Zone 6	Zone 7	Zone 8	Zone 9	Zone 10	Zone 11
RELAY OUTPUT =	___ Min.	Zone 1	Zone 2	Zone 3	Zone 4	Zone 5	Zone 6	Zone 7	Zone 8	Zone 9	Zone 10	Zone 11	Zone 12
ENTRY DELAY TIME #1 =	___ Secs.	Zone 1	Zone 2	Zone 3	Zone 4	Zone 5	Zone 6	Zone 7	Zone 8	Zone 9	Zone 10	Zone 11	Zone 12
ENTRY DELAY TIME #2 =	___ Secs.	Zone 1	Zone 2	Zone 3	Zone 4	Zone 5	Zone 6	Zone 7	Zone 8	Zone 9	Zone 10	Zone 11	Zone 12
EXIT DELAY TIME =	___ Secs.	Zone 1	Zone 2	Zone 3	Zone 4	Zone 5	Zone 6	Zone 7	Zone 8	Zone 9	Zone 10	Zone 11	Zone 12

Installation Record Label

PROGRAMMING RECORD SHEET FOR THE MAGNUM ALERT-850

FEATURE	GROUP 1								GROUP 2							
	ZONE								PANIC	FIRE 8	AR-BUSH	FIRE TBL	DAY TBL	TEST TIMER	NO AC	LOW BAT
	1	2	3	4	5	6	7	8								
REPORT ON ALARM	166	166	166	166	167	167	167	167	168	168	168	168	169	169	169	
CONTROL-CENTER RESTORAL ⁽¹⁾	170	170	170	170	171	171	171	171	172	172	172	172	173	173	173	
ZONE RESTORAL ⁽¹⁾	184	184	184	184	185	185	185	185			4			2	4	
DAY ZONE	186	186	186	186	187	187	187	187								
PRIORITY WITH BYPASS ⁽²⁾	188	188	188	188	189	189	189	189								
PRIORITY	190	190	190	190	191	191	191	191								
REMOVE AUTO-SHUNT ⁽²⁾	192	192	192	192	193	193	193	193								
SELECTIVE SHUNT	194	194	194	194	195	195	195	195								
GROUP SHUNT	196	196	196	196	197	197	197	197								
24-HOUR PROTECTION	198	198	198	198	199	199	199	199								
AUTO-RESET	200	200	200	200	201	201	201	201								
EXIT/ENTRY ZONE (ENTRY DELAY 1)	202	202	202	202	203	203	203	203								
EXIT/ENTRY ZONE (ENTRY DELAY 2)	204	204	204	204	205	205	205	205								
EXIT/ENTRY FOLLOWER	206	206	206	206	207	207	207	207								
ABORT DELAY	208	208	208	208	209	209	209	209								
BURGLARY OUTPUT	210	210	210	210	211	211	211	211								
RELAY OUTPUT	212	212	212	212	213	213	213	213								
7ms LOOP RESPONSE ⁽³⁾	214	214	214	214	215	215	215	215								
50ms LOOP RESPONSE ⁽³⁾	216	216	216	216	217	217	217	217								

TIME EXAMPLE CHART		
(seconds or minutes)		
TIME	1st BOX	2nd BOX
5	5	NONE
15	F	NONE
30	E	1
45	d	2
60	C	3

248	249	TEST-TIMER OFFSET (hours)
-----	-----	---------------------------

DELAY TIME		
218	219	EXIT DELAY (seconds)
220	221	ENTRY DELAY 1 (seconds)
222	223	ENTRY DELAY 2 (seconds)
232	233	ABORT DELAY (seconds)

TIME-OUT		
224	225	BURG. TIME-OUT (minutes)
226	227	RELAY TIME-OUT (minutes)
228	229	FIRE TIME-OUT (minutes)
230	231	DOOR-CHIME TIME (1/4 seconds)

TOUCH-TONE ⁽⁴⁾ DIALING	178
TOUCH-TONE ⁽⁴⁾ /ROTARY BACKUP	178
BACKUP REPORTING	178
DOUBLE REPORTING	178
OPENING REPORT AFTER ALARM	179
CONDITIONAL CLOSING REPORT	179
CONDITIONAL CLOSING/STATUS REPORT	179
SPLIT REPORTING	179
AUDIBLE TEST ON ARMING	180
AUTO RESET AFTER ALARM TIME-OUT	180

COME UP ARMED AFTER POWER FAILURE(4)	180
PULSING BELL OUTPUT	181
RESET OUTPUT-RELAY DEVICES	181
ENABLE ZONE 8 AS FIRE ZONE	181
RESET TEST TIMER ON REPORT	181
DISABLE FAULT FIND	182
ENABLE KEYPAD PANIC	182
ENABLE COMMUNICATOR CONFIDENCE TEST	182
DISABLE BELL TEST	182
DISABLE SWINGER SHUTDOWN	183

Example: For 2 seconds, enter "8" in loc. 230



PROGRAMMING NOTES

- 1 When programming ZONE RESTORAL, CONTROL-CENTER RESTORAL must also be programmed.
- 2 When programming PRIORITY WITH BYPASS, do not program REMOVE AUTO SHUNT.
- 3 If neither 7 nor 50ms LOOP RESPONSE is programmed, loop response will be 750ms.
- 4 Zones 5 and 6 will be delayed. See GLOSSARY.

PROGRAMMING RECORD SHEET FOR THE MAGNUM ALERT 850
Communicator Transmission Information

ALARM/TROUBLE CODES	GROUP 1								GROUP 2							
	ZONE							PANIC 8	FIRE 8	AM BUSH	FIRE TBL	DAY TBL	TEST TIMER	NO AC	LOW BAT	
	1	2	3	4	5	6	7									
Single Digit	000	002	004	006	008	010	012	014	016	018	020	022	024	026	028	
Extended or Two Digit	001	003	005	007	009	011	013	015	017	019	021	023	025	027	029	

RESTORE CODES	GROUP 1								GROUP 2							
	ZONE							PANIC 8	FIRE 8	AM BUSH	FIRE TBL	DAY TBL	TEST TIMER	NO AC	LOW BAT	
	1	2	3	4	5	6	7									
Single Digit	040	042	044	046	048	050	052	054	056	058	060	062	064	066	068	
Extended or Two Digit	041	043	045	047	049	051	053	055	057	059	061	063	065	067	069	

OPENING/CLOSING CODES	Closing User				Conditional Closing	Opening User			
	1	2	3	4		1	2	3	4
	Single Digit	030	032	034		036	038	070	072
Extended or Two Digit	031	033	035	037	039 (1)	071	073	075	077

Select User(s) Closing	1	2	4	8	Select User(s) Opening	1	2	4	8
	174	174	174	174		176	176	176	176

KEYPAD CODES (Do not enter zeros)	Ambush			Program (Must be programmed)				Fallback				
		236	237	238	239	240	241	242	243	244	245	246

SUBSCRIBER I.D. NUMBERS	Alarm/Restora ID (2)				Opening/Closing ID (3)							
	GROUP 1		GROUP 2		GROUP 1		GROUP 2					
	Telephone 1	100	101	102	103	104	105	106	107	108	109	110
Telephone 2	132	133	134	135	136	137	138	139	140	141	142	143

Telephone	Format Rcvr Data	Pre-Dial Delay	Access Number	Dial-Tone Detection	Telephone Number																					
	Telephone 1	112 113	114	115	116	117	118	119	120	121	122	123	124													
	Telephone 2	144 145	146	147	148	125	126	127	128	129	130	131	149	150	151	152	153	154	155	156	157	158	159	160	161	162

ENTRY	RECEIVER FORMAT
Blank	ADEMCO, SILENT KNIGHT "SLOW"
1	SESCOA, VERTEX, DCI, FRANKLIN (4)
2	RADIONICS "FAST" (4)
3	SILENT KNIGHT "FAST"
4	RADIONICS, DCI, FRANKLIN "SLOW" (4)
5	(RESERVED)
6	(RESERVED)
7	RADIONICS BFSK (4)
8	FOR 2300Hz HANDSHAKE, ADD AN "8" TO THIS LOCATION

ENTRY	DATA FORMAT
Blank	EXTENDED OR SINGLE DIGIT
1	SINGLE DIGIT
2	TWO DIGIT (OR 4/2)
4	SUM CHECK

NOTES:

- (1) TWO-DIGIT FORMAT ONLY.
- (2) GROUP-2 CODES MUST BE ENTERED, EVEN IF THEY ARE THE SAME AS GROUP-1 CODES.
- (3) MUST BE PROGRAMMED IF OPENING/CLOSING CODES ARE PROGRAMMED.
- (4) THESE FORMATS TYPICALLY USE A 2300Hz HANDSHAKE; ADD AN "8" TO THIS ENTRY.

GLOSSARY & PROGRAMMING DATA

Abort Delay (Locations 208, 209; 232, 233)

A delay period that allows cancellation of the central-station report. This is done by disarming the control panel within the delay period. Program PROM locations 208, 209 for zone selection; locations 232, 233 for delay time (see **Time Selection**).

NOTE: If Abort Delay is selected for a 24-Hour Zone or a Zone-Restoral Zone, the zone must be cleared before disarming the panel.

Ac-Failure Reporting (Locations 169; 173)

If ac is removed from the control panel, the top three LEDs will blink simultaneously. To arm in this condition, first press Key [9]. If programmed for Report On Alarm, the report will be delayed for 1 hour. Restorals will report immediately.

Access Number for Outside Line (Locations 115, 147)

Some subscribers will have a telephone system that requires one digit to access an outside line before the telephone number can be dialed. Also, the first dial tone encountered (prior to the access number) may have a frequency that is different from that of the accessed dial tone (440Hz). One or more 4-second Pre-Dial Delay "d"s may be entered before the access number instead of a dial tone with frequency "E". See **Pre-Dial Delay**.

If your subscriber's system uses an access number:

1. Contact the telephone-equipment supplier to find out if a dial tone other than 440Hz is received prior to dialing the access number. If the communicator must delay before dialing the access number instead of attempting to recognize the dial tone, find out how many 4-second delays must be programmed.

2. For Telephone 1,

a. Enter the Dial-Tone Detection "E" ([8] [PLUS] [6]) or Pre-Dial Delay "d" ([8] [PLUS] [5]) in location 114. Enter any extra "d"s that may be required starting in location 115.

b. Enter the access number digit in location 115, or the first available location thereafter.

c. Starting in the first available location after the access number, enter any Pre-Dial Delay "d"s needed before the second dial tone; the Dial-Tone Detection "E" for the second dial-tone frequency; then the telephone number.

3. If Telephone 2 is used, repeat Step 2 starting in location 146. (See **Backup Reporting**; **Double Reporting**; and **Split Reporting**.) Also see **Dial-Tone Detection**; **Pre-Dial Delay**.

Alarm Codes See Report on Alarm

Alarm History

Hold-Down Key [S]. This will display (on the digital readout) all alarm conditions that have occurred. While holding down Key [S], note the number(s) displayed indicating the zone(s) violated. When the system is rearmed, the previous alarm history will stay memorized until automatically erased by a new alarm condition.

Alarm Outputs (Locations 181, 210-213; 224-227;
Terminals 27-30;32, 33; Jumpers B, C, E, & F)

The MA-850/850M has an integral siren driver for both burglary and fire alarms, one relay contact output for additional devices, and a communicator that can report alarms to a central station. A bell may be used on the siren output terminals.

The following table summarizes wiring and programming for signaling an alarm in typical installations. See **Time Selection** for time-out durations.

Output	Wiring	Output Locations	Time-Out Locations	Remarks
Sweep Siren*	Speaker on 32, 33	210, 211	224, 225	See Note
Steady Siren	Speaker on 32, 33	4 in 181	228, 229	--
Pulsing Sweep Siren	Speaker on 32, 33	5 in 181	228, 229	--
Steady Bell*	Bell on 32(-), 33(+)	210, 211	224, 225	Cut Jumper E
Pulsing Bell	Bell on 32(-), 33(+)	5 in 181	228, 229	Cut Jumper E
Relay Output	30(-), 28(+)	212, 213	226, 227	
Dry Contacts	27 (COM) 28 (N/O) 29 (N/C)	212, 213	226, 227	Cut Jumper B
Reset Output-Relay Devices	30(-), 29(+)	2 in 181	-- --	Dedicated for Reset
*In U.L. installations, see Time Selection for time-out requirements.				

NOTE: Cut Jumper F to produce a two-tone alternating siren sound; cut Jumper C to prevent the fire signal from sounding a steady siren.

Relay Output. The maximum Relay Output current in standby or alarm is combined with the total standby outputs (including Remote Power and Auxiliary Power Output). If it is desired to utilize a device that will draw up to 1A in alarm, (a) cut Jumper B for dry contacts, and (b) connect Lug E14 (ALARM POWER) to Terminal 27 (common). An alarm device may then be powered from Terminals 28 (+) and 30 (-).

Speaker/Bell Output. Connect one or two (in parallel) 8-ohm, 15-watt speakers across Terminals 32 (-) and 33 (+). Note that Grade-A U.L. installations require a Grade-A sounding device located on an outside wall, with rigid conduit or electrical metallic tubing (EMT) used for the entire length from the upper-right knockout of the control-panel housing to the bell housing. Refer to the following illustration.

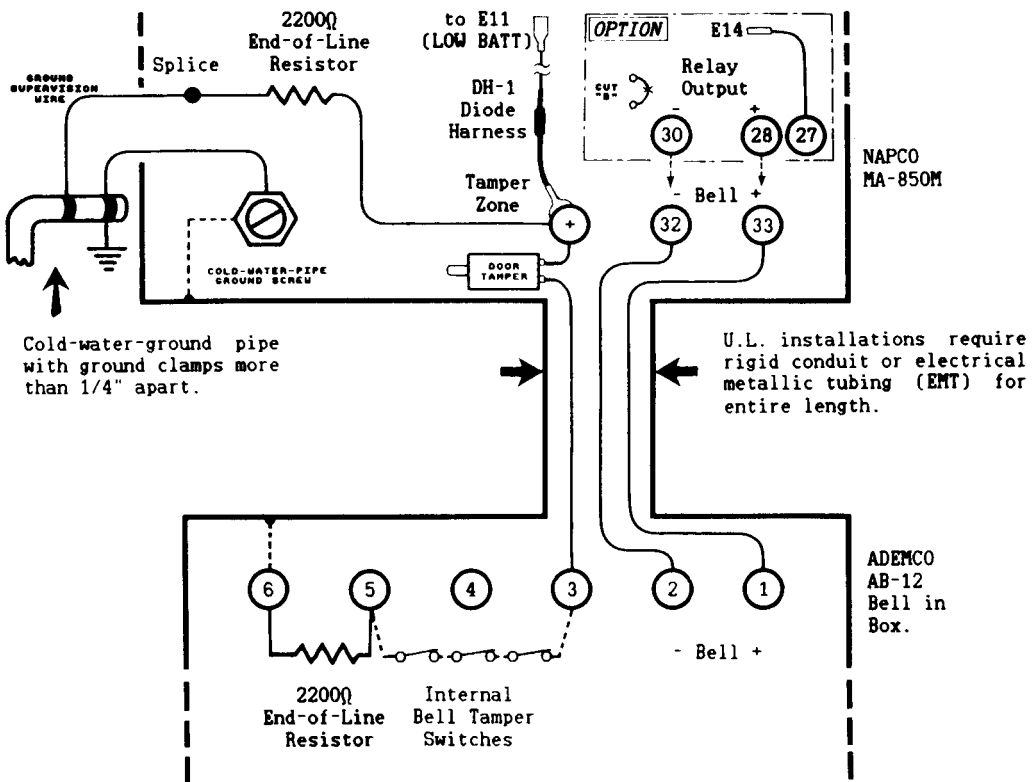

MA-850M Wiring to a Grade-A Bell

Grade-A Local or Grade-B Central Station (MA-850M): Use any Burglary Zone for the Tamper Zone. Program that zone for: 24-Hour Protection (or Day Zone), Priority (or Remove Auto-Shunt), Burglary Output or Output-1 Relay (to activate the bell), and Report On Alarm if central station. Use the supplied door tamper switch and 2200-ohm end-of-line resistors. If local, and not reporting to a central station, the DH-1 Diode Harness is required so that an alarm will sound for a low-battery condition.

NOTE: If Day Zone is programmed for the Tamper Zone, a ground break or a tamper will activate the keypad sounder when disarmed. Hold down Reset Key [9] to silence sounder and clear display; arm and disarm to reset Day Zone. If 24-Hour Protection is programmed (or the system is armed), a ground break, tamper, or low battery will ring the alarm bell. Reset by arming and disarming (or disarming if already armed). If it is desired to have ground supervision or tamper on separate zones, use 1000-ohm end-of-line resistors in place of the 2200-ohm resistors.

Grade-C Central Station (NA-850N): Same as above except that a bell is not required. If not using a bell, connect the door tamper in series with the ground supervision wire, and a 1000-ohm end-of-line resistor in place of the 2200-ohm resistor shown.

Grade-A Police Connect (NA-850N): Wire and program the same as for Grade-A Local. Digital communication is not required. Use the DH-1 Diode Harness to activate the M-278 Line-Reversal Module for Low Battery. See U.L. CLASSIFICATIONS and SUMMARY OF U.L. REQUIREMENTS.

Alarm Power See Alarm Outputs: Relay Output

Ambush Code (Locations 236, 237)

A 1- or 2-digit code that is entered by the user prior to disarming to access the Ambush Zone, causing a silent report to be sent to a central station. Thus, should a user be forced to disarm by an assailant, he can silently signal an emergency while appearing to be merely disarming the system. The Ambush Zone will automatically report when programmed to report on alarm.

To program the ambush feature,

1. Program Ambush to Report on Alarm ("2" in location 168).
2. Enter 1 or 2 digits as the Ambush Code in locations 236-237.
3. Enter an Ambush-Zone alarm report code in locations 018-019.

Inform the user what the Ambush Code is, and that his arm/disarm code must be entered less than 10 seconds after the Ambush Code for an ambush report to be sent.

Easy Arming. The Ambush Code may also be used as a 1- or 2-digit Easy-Arm (arm-only) Code. Program this code into locations 236-237, then enter it as one of the user codes (see **Loading Personal Codes**). The Easy-Arm Code itself cannot disarm the system. Note that no personal code may begin with the same digit(s) as the Easy-Arm Code, as it can't disarm.

When using Ambush and Easy-Arm, caution the user not to enter his personal disarm code less than 10 seconds after the Easy-Arm Code

or an Ambush report will be sent.

Anti-Jam Time (Location 006)

NOTE: The Anti-Jam Time location is contained on PROM Page 1 (see PROGRAMMING STEP 3).

If the communicator does not detect a dial tone within 12 seconds, the Anti-Jam feature will be activated. That is, the communicator will go off line for a 16-second anti-jam interval in order to free the telephone circuit from incoming calls, then make another 12-second attempt at dial-tone detection. If still unsuccessful, the communicator will again go off line for 16 seconds, then proceed to dial anyway.

Consult the telephone-equipment supplier to determine if a longer time is required for the Anti-Jam feature to function. To increase the anti-jam interval from the factory-set 16 seconds to 31 seconds, set the PAGE switch on the PRO-410/410M Programmer to [1], erase memory, and enter an "F" in location 006 (see CAUTION after PROGRAMMING STEP 3.)

To test the Anti-Jam feature, call the alarm phone line from a different phone line, then activate an alarm. The incoming call should be disconnected by the control panel.

Arm Lug (Lug E4)

Lug E4 (ARM) will go to OVdc when the system is armed. This lug may be used for auxiliary equipment, such as an SG-1930 Shock-Guard Processor. For use, refer to the instructions furnished with the peripheral device.

Audible Test on Arming (Location 180)

Note: This feature *must* be selected for U.L. installations.

To test the alarm circuit each time the system is armed, add a "1" to location 180. The alarm is then activated briefly about 4 seconds after the control panel is armed. If the alarm does not sound, the device may be defective.

Auto-Reset (Locations 180; 200, 201)

If a zone signals an alarm and is selected for Auto-Reset, it will automatically rearm itself as soon as the alarm condition is cleared. Auto-Reset may be delayed to occur after the time-out period by programming a "2" in location 180.

Zones 1 through 8 that are not programmed for Auto-Reset will not be capable of signalling another alarm until (a) the cause of the alarm has been cleared and (b) the control panel is disarmed.

Also see Disable Swinger Shutdown.

Auto-Reset After Alarm Time-Out See Auto-Reset

Auto-Shunt Zone See Remove Auto-Shunt

Backup Reporting (Location 178)

When Backup Reporting is selected and the communicator does not reach the first telephone number after two attempts, seven attempts will be made to reach the second telephone number. Enter Subscriber Identification Numbers for Telephone 2 (locations 132-143) and other information required for Telephone 2 (locations 144-163). If Double Reporting is selected with Backup Reporting, all reports sent to the first telephone number will also be transmitted to the second telephone number. However, if the first transmission fails, *two* reports will be sent to Telephone 2 (Double Reporting).

NOTE: Subscriber Identification Numbers for both Telephones 1 and 2 *must* be entered, even if they are the same.

Battery, RBAT4, RBAT6

12Vdc standby power source in the control panel to provide backup protection in the event of a power loss. One RBAT4 battery (4AH) is supplied with each MA-850; one RBAT6 (6AH) is supplied with each MA-850M. The battery is an integral part of the system and *must* be installed, even if ac power is present.

Burglary Lug (Lug E10)

Lug E10 (BURG) will go to approximately 1Vdc when a burglary alarm is tripped. E10 may be used to trip an LW-900 Long-Range Wireless Interface. Or, a relay (400 ohms minimum) may be connected to E10 if a diode is inserted in series (cathode to E10; anode to relay).

Burglary Output See Alarm Outputs

Call Waiting See Disable Call Waiting

Closing Report (Select User(s) Closing) (Location 174)

Conditional Closing Report (Locations 179; 038, 039)

Conditional Closing/Status Report (Locations 179; 000-029; 038, 039)

On arming, the communicator can transmit a closing code for each user, a conditional-closing code, and a status report that identifies the problem zone to the central station. Note that Subscriber Identification Numbers (locations 108-111; 140-143) and Closing Codes (locations 030-037) *must* be entered for any closing

report. Program (unconditional) closing report (Select User(s) Closing, location 174) to report each time the control panel is armed. Each of up to four users may have his own Closing Code (locations 030-037).

Select Conditional Closing ("2" in Location 179) to report only when arming with an auto-shunted zone. This transmission will consist of a Closing Code followed by a Conditional-Closing Code.

Select unconditional and conditional closing report to always send a closing report, and a conditional-closing report only if a problem exists. Arming with a priority zone bypassed (see **Priority Zone with Bypass**) will cause a conditional-closing report.

Select Conditional Closing/Status Report ("4" in location 179) to send a Conditional-Closing followed by a status report that identifies the problem zone(s). The second Alarm-Code location is generally used for this purpose. If this location is vacant, the first location will be used.

A typical Conditional Closing/Status Report is represented by the following example.

Example. A burglar breaks into a commercial establishment during the night, breaking the window foil. The Alarm Subscriber Identification Number is "123"; the Alarm Code is "1" (Burglary Zone 1); the Opening/Closing Subscriber Identification Number is "456"; the Conditional-Closing Code is "F"; the Closing Code for User 1 is "C". The communicator will send the following report to the central station (single-digit data format):

1231 - Sent when alarm occurs.
456C - Closing: User returned; inspected damage; rearmed.
456F - Conditional Closing.
FFF1 - Zone status at time of closing: Window foil still broken. Zone 1 auto-shunts; repair required.

Come Up Armed After Power Failure (Location 180)

When a "4" is programmed into location 180, the control panel will return in an armed state when ac is restored after an extended power failure (and the backup battery is dead). Also, Zones 5 and 6 will be delayed for 3 to 4 minutes so that devices such as PIRs are allowed sufficient time to reset (warm up).

Control-Center Restoral See Restoral Report

Data Format (Locations 113, 145)

Consult the central station to find out which of the following formats to use.

Extended Format. Extended-format reporting allows the communicator to transmit an extra digit to the central station. This extra digit is generally used to report the user or the zone on which the event occurred.

Example. An installation uses the following programmed transmission information: Subscriber Identification Number is "678"; a Closing Report is selected for User 3; Extended Format Closing Code is "C3" (Closing, User 3). If User 3 closes, the communicator will transmit:

678C - Subscriber "678" has closed.
CCC3 - Closing, User 3.

Extended Format may be used with most central-station receivers. Most receivers capable of recognizing multiple reporting will also recognize Extended Format. The central station will indicate the event codes to be programmed. Extended Format does *not* require any programming in locations 113 and 145. To use Extended Format, follow Steps 2 through 5 of **Two-Digit Event-Code Format** later in this section.

Single-Digit Event Code Format. If the receiver cannot accept extended reporting,

1. Program a "1" in location 113 (and 145 for a second telephone number, if used). See **Double Reporting** and **Backup Reporting**.
2. Enter the first digit for any Alarm/Trouble Code, Restore Code and Opening/Closing Codes.

NOTE: If it is desired to have a Single-Digit Event Code for one telephone number and Extended Format for the other, program both digits for all event codes. Use the first digit to indicate the alarm type and the second digit to indicate the zone. The telephone number with a "1" in location 113 (or 145) will transmit only the first digit. The other telephone number will use both digits. (Single-Digit Format will ignore the second digit of the event code.)

Two-Digit Event Code Format. Some central-station receivers require that a two-digit code be sent in each report.

Example. In a certain installation, the Alarm Subscriber Number is "123"; a burglary alarm occurs on Zone 1 (Alarm Code "31"). The communicator will send "12331".

To use Two-Digit Event Code Format,

1. Program a "2" in location 113 (145 for a second telephone number, if used). See **Double Reporting** and **Backup Reporting**.

2. Enter an Alarm Code (locations 000-029) for each zone or condition to report on alarm (see **Report on Alarm**) or for a Conditional Closing/Status Report as follows:
 - a. Enter the first digit of the Alarm Code. (This digit may be used to indicate alarm type.)
 - b. Enter the second digit of the Alarm Code. (This digit may be used to indicate the zone.)
3. Repeat Step 2 to enter Restore Codes (locations 040-069) for each zone selected for Control-Center Restoral or Zone Restoral (see **Restoral Report**).
4. If Opening Report or Opening Report After Alarm is selected, enter a two-digit Opening Code for each user (locations 070-077). See **Opening Report; Opening Report After Alarm**.
5. If Closing Report is selected, enter a two-digit Closing Code (locations 030-037) for each user. If a Conditional Closing or Conditional Closing/Status Report is selected, also enter a two-digit Conditional-Closing Code (locations 038, 039).

NOTE: Single-Digit Format will override Two-Digit Format location 113 or 145.

Sum-Check Format. Sum Check is a sophisticated data format used to enhance the speed and check the accuracy of the received transmission. This format should be preferred whenever the central station is capable of receiving it.

After transmitting the Subscriber Identification Number and the event code, the communicator sends a verifying digit that is the sum of both. The receiver compares the verifying digit with the sum of the other two numbers to check transmission accuracy. To select Sum Check, program a "4" in location 113 (or 145 for a second telephone number, if used).

Day Zone (Locations 186, 187)

A Burglary Zone programmed to cause visual and audible indication at the keypad if the loop has an open condition only when disarmed. This feature may be used to warn of trouble during the day, when the panel is not armed. If the Day Zone experiences a problem (a break in a window foil, for example), the green STATUS LED on the keypad will flash, the sounder will beep repeatedly, and the digital readout will display the problem zone(s). Hold down Reset Key [9] to silence the sounder and clear the display. Arm and disarm the panel to reset the Day Zone.

Dial-Tone Detection (Locations 116, 148)

At least one Dial-Tone Detection entry is usually required for each telephone number used to ensure that a dial tone is present before the communicator dials.

When an "E" ([8] [PLUS] [6]) is programmed before the first digit of an outside telephone number, the communicator dial-tone detection circuit is set to detect the standard 440Hz dial tone. The "E" is generally entered in location 116 for Telephone 1 and location 148 for Telephone 2, if used.

It may be necessary to program at least one 4-second Pre-Dial Delay before a Dial-Tone Detection "E". With certain nonstandard exchanges, Pre-Dial-Delay "d"s may be used without a Dial-Detection "E". (See **Access Number for Outside Line; Pre-Dial Delay.**)

Disable Bell Test (Location 182)

Program an "8" in location 182 to prevent unauthorized persons from sounding the bell or siren.

Disable Call Waiting

A digital communicator connected to a telephone line with *Call Waiting* may be disrupted by this feature. However, most lines with *Call Waiting* also have *Selective Call Waiting*, which permits the feature to be turned off by dialing a "*70" just before the telephone number. A "*" will be dialed by programming a "b".

If the installation has the *Call Waiting* feature, be sure that it also has *Selective Call Waiting*, and confirm the disable code with the telephone company. Then program this code ("*70") directly before the phone numbers in the telephone-number locations. See **Telephone Numbers.**

Caution: Should the user cancel his *Call Waiting* feature, the communicator will dial a wrong number. It will then be necessary to change the PROM to correct the phone number.

Disable Fault Find (Location 182)

Program a "1" in location 182 to prevent unauthorized use of the Fault-Find mode. See **HOLD-DOWN FUNCTION 7.**

Disable Swinger Shutdown (Location 183)

Normally, Zones 1 through 6 with Auto-Reset will only reset twice (3 alarms) until rearmed in order to prevent "swingers" (inter-

mittents) from causing repeated false alarms, See **Auto-Reset**. The Swinger-Shutdown feature is not applicable to Zones 7 and 8. To disable Swinger Shutdown on all zones, program a "1" in location 183.

Door Chime (Zone 1)

This annunciator feature may be used on Zone 1 while disarmed to sound a beep at the keypad when the zone goes into trouble. Press hold-down function Key [5] until it beeps to enable or disable the Door Chime. Chime duration is programmable (locations 230, 231) in units of 1/4 seconds. See **Time Selection**.

Double Reporting (Location 178)

When Double Reporting is selected, if, *and only if*, information is successfully sent to Telephone 1, will it be sent to Telephone 2 as well.

To program Double Reporting, enter an "8" in location 178. Enter Subscriber Identification Numbers for Telephone 2 (locations 132-143) and related information required for Telephone 2 (locations 144-163).

If Backup Reporting is selected with Double Reporting, reports sent to the first telephone number will also be transmitted to the second telephone number. However, if the first transmission fails, two reports will be sent to Telephone 2.

Split Reporting will override Double Reporting if both are programmed.

NOTE: Subscriber Identification Numbers for both Telephones 1 and 2 *must* be entered, even if they are the same.

"E" Lugs (E3, E4, E5, E9, E10, E11, E12, E14)

- E3 - See **Ground-Start Module, GSM-400**
- E4 - See **Arm Lug**
- E5 - See **Listen-In Module**
- E9 - See **Fire Lug**
- E10 - See **Burglary Lug**
- E11 - See **Low Battery**
- E12 - See **Relay Control**
- E14 - See **Alarm Outputs: Relay Output**

Easy Arm See **Ambush Code**

Enable Communicator-Confidence Test (Location 182)

Program a "4" in location 182 to enable the Communicator-Confidence Test. See **HOLD-DOWN FUNCTION 6**.

Enable Keypad Panic See Panic Zone

Enable Zone 8 as Fire Zone See Fire Zone

Exit/Entry Delay (Locations 218-223)

Permits exit and entry through the Exit/Entry Zone(s) (see locations 202-205) after the system is armed without setting off an immediate alarm. Exit delay allows the user to leave the premises after the panel has been armed. Entry delay allows the user time to enter and disarm the panel. Upon entering, the keypad sounder will sound a steady tone to remind the user to disarm the panel.

Two individually-programmable entry-delay times are provided to accommodate different entry zones (one exit delay is sufficient for all). If two or more Exit/Entry Zones are entered in succession, the delay programmed for the last Exit/Entry Zone entered will take precedence over all others.

Exit-Delay time (locations 218-219) and Entry-Delay time (locations 220-223) may each be programmed for up to 255 seconds (4-1/4 minutes). See **Time Selection**. If delay times are not programmed, exit delay will be 60 seconds; entry delay 30 seconds.

NOTE: In U.L. installations, Exit-Delay time may not exceed 60 seconds; Entry-Delay time may not exceed 60 seconds for mercantile installations, 45 seconds for residential installations.

Exit/entry delay may be cancelled by hold-down function Key [4] (Instant Protection) prior to arming, however it will be automatically restored upon disarming.

Exit/Entry Follower (Locations 206, 207)

A zone programmed as an Exit/Entry Follower will ignore detection during the exit delay, and *only* during entry delay if the Exit/Entry Zone is entered *first*. Thus, detection devices (passive infrared detectors, for example) along the path between the keypad and the exit/entry door will not signal an alarm during exit/entry delay under normal conditions. However, if a device in the Exit/Entry Follower Zone detects a violation when the exit/entry door has not first been entered, there will be no entry delay and the Exit/Entry Follower Zone will go into an instant alarm.

If the panel is armed with the entry delays cancelled (Instant

Protection), any violation on the Exit/Entry Zone or the Exit/Entry Follower Zone will cause an immediate alarm.

Extended Format See Data Format

Fallback Code (Locations 244-247)

After an extended power failure (longer than battery standby capacity), all personal codes will be erased. Should this occur, the system will fail to respond to any personal code, but will respond to the 4-digit Fallback Code that is programmed into PROM locations 244-247 until the personal codes can be restored. The Fallback Code will only function when all personal codes have been lost. To prevent unauthorized entry using the Fallback Code, personal codes should be restored as soon as possible.

Fire Lug (Lug E9)

Lug E9 (FIRE) will go to approximately 1Vdc when a fire alarm is tripped. E9 may be used to trip an LW-900 Long-Range Wireless Interface. Or, a relay (400 ohms minimum) may be connected to E9 if a diode is inserted in series (cathode to E9; anode to relay).

Fire Zone (Location 181)

Programming a "4" in location 181 will enable Zone 8 supervision by the bottom red keypad LED. Normally-open devices are connected to Zone 8 (Terminals 10 and 11). A short across Zone 8 will cause a fire alarm, a steady-on red LED and a pulsing keypad sounder. An open circuit will cause a blinking red LED and a pulsing sounder after a 10-second delay. The sounder may be silenced using Reset Key [9]. The LED will go off within 30 seconds after reset if the alarm or trouble is cleared.

If the Fire Zone is selected to Report on Alarm (location 168) or to Restore (location 172), the Alarm Codes in locations 016-017 and the Restore Codes in locations 056-057 will be sent. Trouble and Restore Trouble on the Fire Zone are reported in locations 020-021 and 060-061, respectively.

NOTE: (a) Even though Zone 8 is used as the Fire input, Keypad Panic may still be used with any features selected for Zone 8, and may report an alarm using locations 014-015. (b) If neither ENABLE ZONE 8 AS FIRE ZONE nor ENABLE KEYPAD PANIC is programmed, Zone 8 may be used as a regular Burglary Zone.

Grade-A Bell See Alarm Outputs

Ground-Start Module. GSM-400 (Lug E3)

If the dial tone is not continuously active, Ground-Start Module

Model GSM-400 will be required at Lug E3 to establish the dial tone. For installation, refer to the instructions furnished with the GSM-400.

Group Shunt (Location 196, 197)

Removal of a preset group of zones from the system. Group shunting is often used to deactivate some or all interior zones simultaneously so that the user may move freely throughout the premises but still be protected from intrusion through armed perimeter zones.

Group shunting is accomplished by pressing Key [S] *twice*. The next time the control panel is disarmed, all shunted zones will automatically revert to non-shunted zones.

When group shunting is selected, the yellow SHUNT LED on the keypad will light. The zones shunted may be confirmed by holding down Display Shunt Key [2] until the sounder beeps. While holding the key down, check the digital display to see the zone(s) shunted.

Jumpers (B, C, E, F) See Alarm Outputs

Keypad Panic See Panic Zone

Line-Reversal Module. M-278

The Line-Reversal Module allows the control panel to be monitored by a central station through leased lines. On alarm, the module reverses normal line-voltage polarity. For details, refer to the instructions furnished with the module.

Listen-In Module (Lug E5)

If installation requires a Listen-In Module, connect the module to Lug E5. The voltage (12V) at E5 drops to zero when the communicator goes off-hook. When the communicator transmission is completed, the voltage at E5 returns and the Listen-In Module can occupy the phone line.

Loop Response (Locations 214-217)

Loop response is the amount of time that a normally-closed circuit must remain open, or a normally-open circuit must remain closed, to trigger an alarm. The slower the loop response, the more immune the system will be to intermittents ("swingers"). Selectable loop-response times are:

750ms (.75 sec.): The slowest loop-response time, recommended for

use with magnetic contacts, window foil, etc. Unless programmed otherwise, loop-response time will be 750ms (milliseconds) for all zones.

50ms (.05 sec.): Used for momentary Panic Buttons and area-protection devices, such as photoelectric eyes, passive infrared sensors, floor mats, etc.

7ms (.007 sec.): An extremely fast loop response used primarily for window bugs, and to eliminate the need for a pulse extender.

Low Battery (Location 169, 173; Lug E11)

A low-battery alarm will signal when the battery terminal voltage drops to 11.0V. A low-battery condition may report to a central station by programming a "4" in location 169. Lug E11 (LOW BATT.) will go to 0Vdc when a low-battery condition exists. E11 may be used to trigger an LW-900 Long-Range Wireless Interface.

No Ac See Ac-Failure Reporting

Opening & Closing Codes See Opening Report; Closing Report

Opening Report (Select User(s) Opening) (Location 176)

Opening Report After Alarm (Location 179)

Opening and closing reports are generally used in commercial installations. On disarming, the communicator can send an opening code for each user (Opening Report), or it may transmit only when the control panel is disarmed after an alarm has occurred (Opening Report After Alarm). Note that Subscriber Identification Numbers (locations 108-111; 140-143) and Opening Codes (locations 070-077) *must* be entered for either opening report.

Program Select User(s) Opening (location 176) to report each time the control panel is disarmed. Each of up to four users may have his own Opening Code (locations 070-077). If selecting Opening Report, *do not* select Opening Report After Alarm.

Program Opening Report After Alarm ("1" in location 179) to report only when disarming after an alarm. This feature may be used by the central station to verify that the subscriber has responded to the alarm and disarmed the panel. If Opening Report After Alarm is selected, *do not* select Opening Report.

Panic Zone (Zone 8)

When using Zone 8 for Panic, program 24-Hour Protection ("8" in location 199) and Report On Alarm ("8" in location 167). Note that if Zone 8 is not programmed for 24-Hour Protection, Panic may still be activated when disarmed, but an "8" will be dis-

played on the digital readout and the red LED will flash.

To enable Panic from the keypad, program a "2" in location 182. The Panic Zone is accessed by pressing the two Panic Buttons (Keys [*] and [#]) *simultaneously*, activating the communicator to alert the central station of an emergency. Keypad Panic may be disabled either by programming or by cutting the brown jumper at the lower end of the keypad circuit board, behind Key [S].

External panic switches may be connected to the black and pink Remote-Panic wires on the RP-1009 keypad (see Wiring Diagram). (If remote panic will not be used, insulate both black and pink leads, as a short between them will cause a panic alarm.) External panic buttons may also be used on Zone 8 input terminals except when Zone 8 is enabled as the Fire Zone. Note that in U.L. installations, remote-panic buttons must be located in the same room as the keypad.

NOTE: Even though Zone 8 is used as the Fire input, Keypad Panic may still be used with any features selected for Zone 8, and may report an alarm using locations 014-015. Do not program the Panic Zone (Zone 8) for a Restoral Report, or a restoral will be sent as soon as the Panic Buttons are released.

Pre-Dial Delay Locations (114, 146)

A Pre-Dial Delay may be used whenever a delay is required before dialing. It is usually required to program Dial-Tone Detection, which causes the communicator to wait for a dial tone before dialing (see **Dial-Tone Detection**). Certain telephone exchanges send a nonstandard dial tone that the communicator may not be able to detect. With these nonstandard exchanges, it is possible to program Pre-Dial Delay rather than Dial-Tone Detection. This will cause the communicator to wait for a predetermined period of time before dialing rather than look for a nonstandard dial tone.

Contact the telephone-equipment supplier to find out how long a delay is required before dialing. Select Pre-Dial Delay by programming one "d" ([8] [PLUS] [5]) for each 4-second delay required. Enter Pre-Dial Delay "d"s starting in location 114 for Telephone 1. If Telephone 2 is used, enter Pre-Dial Delay "d"s starting in location 146.

See **Backup Reporting**; **Double Reporting**; **Split Reporting**. Also see **Access Number for Outside Line**.

Priority Zone (Locations 190, 191)

A zone that will prevent arming if in trouble. If an attempt is made to arm, the sounder will sound continuously and a "0" will be displayed on the digital readout. The priority condition may be silenced by disarming. Any zone may be selected as a Priority

Zone. A zone in trouble that is neither a Priority Zone nor an Auto-Shunt Zone will cause an alarm on arming.

Priority Zone with Bypass (Locations 188, 189)

A Priority Zone that will permit arming if the priority condition is bypassed (Reset Key [9] must be depressed for about 2 seconds before entering arm/disarm code). If the system is so programmed, the zone will auto-shunt, and (optional) the condition will be reported to a central station. Any zone not selected as a Priority Zone may be programmed as a Priority Zone with Bypass. When programming a zone as Priority with Bypass, do not program Remove Auto-Shunt. See **Conditional Closing**.

Program Code (Locations 238-243)

This code is required to enter the Program Mode (which allows an authority to load personal codes, see **BASIC OPERATION - PERSONAL CODES**). Enter the 3- to 6-digit Program Code starting in location 238. Hold down Key [8] to access the Program Code (see **HOLD-DOWN FUNCTION KEY [8]** in Section 2).

Pulsing Sweep Output See Alarm Outputs

Receiver Format (Locations 112, 144)

The communicator can be programmed to transmit to any standard central-station receiver. A receiver format must be entered for each telephone number used, but a different format may be assigned to each.

Refer to **Double Reporting** and **Backup Reporting** to determine whether or not Telephone 2 will be programmed. Call the central station for each telephone number used to confirm the type of receiver in use. Select the receiver format entry for each telephone number from the following table.

ENTRY	RECEIVER FORMAT	DATA FREQ.	DUTY CYCLE (ON/OFF)	INTERDIGIT TIME
(blank)	Ademco, Silent Knight "slow"	1900Hz	60/40mS	600mS
1	Sescoa, Vertex, DCI, Franklin	1800	30/20	800
2	Radionics "fast"	1800	13/12	400
3	Silent Knight "fast"	1900	40/30	560
4	Radionics, DCI, Franklin "slow"	1800	60/40	600
5	Reserved			
6	Reserved			
7	Radionics BFSK			
8	Add "8" for 2300Hz handshake; Do not add if 1400Hz handshake.			

Program the receiver-format entry in location 112 for Telephone 1

and location 144 for Telephone 2, if used.

Relay Control (Lug E12)

Lug E12 (RELAY) will go to about 1Vdc when the relay is tripped. This may be used to trip an LW-900 Long-Range Wireless Interface. Or, a relay (400 ohms minimum) may be connected to Lug E12 if a diode is inserted in series (cathode to E12; anode to relay).

The Fire Zone cannot be programmed to activate the relay output, however Lug E12 may be used. Connecting a diode from the FIRE lug E9 (cathode) to E12 (anode) will activate the relay when the Fire Zone is tripped.

Relay Output See Alarm Outputs

Remove Auto-Shunt (Locations 192, 193)

All zones are preprogrammed for Auto-Shunt, and will be bypassed (automatically shunted out) if in trouble when arming. A momentary beep will sound at the keypad to warn that the system has been armed without the protection of the auto-shunted zone. (Note that the exit/entry door must be closed before arming, otherwise the Exit/Entry Zone will be auto-shunted.) Auto-shunting may be removed from any Zone 1-8 by programming.

NOTE: If auto-shunt is removed from a zone in trouble that is not programmed for Priority arming (locations 190, 191), that zone will cause an alarm on arming. If selecting Priority with Bypass, do not select Remove Auto-Shunt.

For U.L. installations, non-24-Hour Zones *with* auto-shunt (Remove Auto-Shunt *not* programmed) must be programmed for Priority Zone with Bypass. If an attempt is made to arm with these zones in trouble, the sounder will come on, a "0" will be displayed, and the panel will not arm. To arm, enter the arm/disarm code; hold down Reset Key [9] for about 2 seconds; then enter the arm/disarm code again.

Report on Alarm (Locations 166-169)

Violation of a zone selected to Report on Alarm will cause the communicator to transmit the code selected for that zone to the central station. Enter Alarm Codes (locations 000-029) for each zone to report on alarm, even if identical codes are used for different zones.

Reset Output-Relay Devices (Location 181)

If detection devices used require removal of dc voltage to reset, program a "2" in location 181 and wire the device power leads to Terminals 29 (+) and 30 (-). Holding down Reset Key [9] until the

sounder beeps will remove power from Terminal 29 for 3-4 seconds.

NOTE: If the relay connected to Terminal 29 is used to reset output-relay devices, it may not be used for other purposes.

Reset Test Timer on Report See Test Timer

Restoral Report

Restoral, Control Center (Locations 170-173)

Restoral, Zone (Locations 184, 185)

If programming Zone Restoral, Control-Center Restoral must be programmed as well. When selecting a Restoral Report, (a) Subscriber Alarm/Restoral Identification Numbers *must* be programmed for Telephone 1 (locations 100-107) and Telephone 2 (locations 132-139), if used; and (b) Restore Codes (locations 040-069) *must* be entered for each zone selected to report a restoral.

When selecting Zone 8 as a Panic Zone, *do not* program it for a Restoral Report, otherwise a restoral will also be sent.

The communicator can transmit a report to the central station when a zone or the control panel is restored. To select the time of reporting, refer to the following table.

PROGRAM:	FOR CONTROL-CENTER RESTORAL REPORT TO BE SENT:	AND FOR ZONE RESTORAL REPORT TO BE SENT:	
Instant Auto-Reset (locations 200, 201)	<ul style="list-style-type: none"> ■ When zone is repaired, or ■ When control panel is disarmed 	<ul style="list-style-type: none"> ■ When zone is repaired, whether control panel is armed or disarmed 	
Auto-Reset After Alarm Time-Out (locations 200, 201; "2" in location 180)	<ul style="list-style-type: none"> ■ When resets (alarm times out & zone is repaired), or ■ When control panel is disarmed 	<ul style="list-style-type: none"> ■ When zone resets (alarm times out & zone is repaired, whether control panel is armed or disarmed) 	
X		X	
		(See Note 2) ZONE REPAIRED WITH CONTROL CENTER	
		ARMED	DISARMED
No Auto-Reset	<ul style="list-style-type: none"> ■ When control panel is disarmed (regardless of zone condition) 	<ul style="list-style-type: none"> ■ When control panel is disarmed 	<ul style="list-style-type: none"> ■ When control panel is armed & disarmed again
<p>NOTE:</p> <ol style="list-style-type: none"> 1. 24-Hour Zone restorals are sent as shown under ZONE RESTORAL. 2. It is recommended that Zone-Restoral or 24-Hour Zones be programmed with Auto-Reset or Priority to prevent accidental auto-shunting of a latched zone. 			

Restore Codes See Restoral Report.

Select User(s) Closing See Closing Report

Select User(s) Opening See Opening Report

Selective Shunt (Locations 194, 195)

Removal of one particular zone from the system. Any or all Zones 1-8 programmed for selective shunt may be removed from the system, but each must be removed separately.

Selective shunting is accomplished by pressing Shunt Key [S] followed by the zone number. The next time the panel is disarmed, all shunted zones will automatically revert to non-shunted zones.

When one or more zones is shunted, the yellow SHUNT LED on the keypad will light. The zones shunted may be confirmed by holding down Display Shunt Key [2] until it beeps; with the key depressed, the shunted zones will be displayed on the digital readout.

Single-Digit Format See Data Format

Smoke Detectors (Terminals 29-31)

Smoke detectors are normally connected to Terminals 29 (+) and 30 (-), as shown in the Wiring Diagram. In this configuration, the smoke detectors will be reset by the normally-closed contacts of the relay connected to Terminal 29. If they are of the self-resetting type, the smoke detectors may be powered from the Constant Auxiliary Voltage Output at Terminal 31 (+), rather than Terminal 29, thus freeing the relay for other purposes. Note, however, that if the relay is used to reset the smoke detectors, it may not be used for any other purpose.

Split Reporting (Location 179)

Split Reporting causes all reports except Low Battery, Openings and Closings to be sent to one receiver, while Low Battery, Openings and Closings report to a second receiver. Split Reporting will override Backup Reporting or Double Reporting if either combination is programmed.

If Split Reporting is selected, enter Subscriber Identification Numbers for Telephone 2 (locations 132-143) and other information required for Telephone 2 (locations 144-163).

NOTE: Subscriber Identification Numbers for both Telephones 1 and 2 *must* be entered, even if they are the same.

Subscriber Identification Numbers (Locations 100-111; 132-143)

Different Subscriber Identification Numbers may be used by the central station to distinguish Alarm and Restoral Reports (locations 100-107) from Opening and Closing Reports (locations 108-111). Similarly, different numbers may be used to distinguish Alarm/Restoral Reports for Group 1 zones (Zones 1-8) from Group 2 zones (Fire to Low Battery). Both groups *must* be programmed, even if both use the same number. See **Report on Alarm; Restoral Report; Opening Report; Closing Report.**

Furthermore, if a second telephone is used, different Subscriber Identification Numbers may be required for Alarm/Restoral Reports (locations 132-139) and Opening/Closing Reports (locations 140-143). As above, both groups *must* be programmed, even if both use the same number. See **Double Reporting; Backup Reporting.**

NOTE:

1. If the central station cannot accept two-digit or extended event codes, the Alarm and Restore Codes may be the same as the Opening and Closing Codes or the Alarm/Restore Codes may be the same for Groups 1 and 2 if the respective Subscriber Identification Number is different.
2. Starting at the left-most location, enter at least 3 digits for each Subscriber Identification Number, even if the first two are zeros. A fourth digit is available for those receivers capable of recognizing 4-digit subscriber codes.

Sum Check See Data Format

Supervisory Zone See Fire Zone

Telephone Numbers (Locations 117-131; 149-163)

To report to a central station, Telephone Number 1 (locations 117-131) *must* be programmed. Telephone Number 2 (locations 149-163) is programmed if Backup Reporting, Split Reporting or Double Reporting is selected.

Telephone Number 1 will be preceded by at least one Dial-Tone Detection entry ("E" in location 116) or Pre-Dial Delay entry ("d" in location 114) to ensure that the communicator detects a dial tone or waits a reasonable time to access a telephone line

before dialing. (See **Dial-Tone Detection; Pre-Dial Delay.**) Furthermore, private telephone systems may require a separate Dial-Tone Detection or Pre-Dial Delay digit, followed by an Access Number (location 115) to obtain an outside line. (See **Access Number for Outside Line.**)

It should be noted here that Telephone Number 1 need not actually start in location 117 nor end in location 131, as extra locations have been provided to allow for additional prefix digits, if required. What is important is that Telephone Number 1, with its associated Pre-Dial Delay, Access Number, and Dial-Tone Detection, be wholly contained within locations 114-131, and that they be in their proper sequence. It may, in fact, be advantageous to leave two or three blank locations before entering the telephone number to allow for the unexpected (an additional Pre-Dial Delay, for example).

The extra locations within the Telephone Number group may also be used to correct telephone-number programming errors. To correct an error, enter an "F" ([8] [PLUS] [7]) in the location with the incorrect digit and enter the correct digit in the following location. The "F" will be ignored by the communicator when dialing.

The above is true for Telephone Number 2 (locations 149-163) as well.

Test Timer (Locations 024, 025, 169, 181)

When a "1" is programmed into location 169, a daily test report will be transmitted to the central station from the time the control panel is powered up. The respective Alarm Code is programmed into locations 024, 025.

By entering an "8" in location 181, the timer will be programmed to send a daily test only if there has been no other report. (Note that this, or the above, is required in U.L. installations). Thus, if one normally reports an opening every weekday morning, for example, this feature may be utilized to maintain reporting continuity on weekends.

Test-Timer Offset (Locations 248, 249)

If the test timer is programmed, it will report immediately upon power-up, and every 24 hours thereafter. To delay the timer reporting time (*timer offset*) up to 24 hours from power-up time, program locations 248 and 249 in hours (see **Time Selection**). (If these locations are left blank, the test timer will report immediately upon power-up.)

Keypad Timer Offset. As an alternative to programming the PROM, a timer offset may be entered at the keypad. (An offset time entered at the keypad will override any offset time programmed in the PROM.) Entering an offset time is similar to loading a Personal Code. Hold down Key [8] until the sounder beeps, then enter the Program Code to access the program mode. Press [S], then [9], then one of the following entries, "1" through "91".

NOTE:

1. Only the following offset times are available. Do not attempt to enter numbers other than those listed below.
2. The accuracy of the offset time listed is +0/-1 hour; that is, the report may be as much as 1 hour early. However entering "91" will cause an instant report.

Entry	Offset	Entry	Offset
1	24 hrs	11	8 hrs
2	23	21	7
3	22	31	6
4	21	41	5
5	20	51	4
6	19	61	3
7	18	71	2
8	17	81	1
9	16	91	0

Press [S] twice to exit the program mode. Exiting with no time entered will give an offset time of 25 hours.

The easiest and most accurate way to offset the test-timer report is as follows. Completely reset the timer by entering "91"; the test timer will report immediately. Then key in the desired offset entry. The test timer will report precisely at the selected offset time, and every 24 hours thereafter.

Time-Out (Locations 224-231)

Time-Out specifies the length of time that an alarm, alert, or delay will remain active. Abort-Delay time and Burglary Time-Out must be programmed, or the feature will not activate. See **Time Selection**.

NOTE: In California, do not program a time-out for fire alarms.

Time Selection Also see Programming Sheet

The following times are programmable:

TIME	LOCATIONS	UNITS	MAX. PROGRAMMABLE TIME
Abort Delay (See Note 1)	232, 233	seconds	4 min., 15 sec. (255 sec)
Exit Delay (See Note 2)	218, 219	seconds	4 min., 15 sec. (255 sec)
Entry Delay 1 (See Note 2)	220, 221	seconds	4 min., 15 sec. (255 sec)
Entry Delay 2 (See Note 2)	222, 223	seconds	4 min., 15 sec. (255 sec)
Burglary Time-Out (See Notes 1 & 3)	224, 225	minutes	4 hr., 15 min. (255 min)
Relay Time-Out	226, 227	minutes	Untimed (See Note 4)
Fire Zone 8 Time-Out	228, 229	minutes	Untimed (See Note 4)
Door-Chime Duration	230, 231	¼ seconds	Untimed (See Note 4)
Timer Offset	248, 249	hours	23 hr. (See Note 5)

NOTES:

1. If both locations are left blank, this feature will not activate (time-out = 0).
2. If both locations are left blank, Exit Delay will be 60 seconds, Entry Delay will be 30 seconds.
3. Must be at least 4 minutes in Residential U.L. installations. In Commercial U.L. installations, must be at least 15 minutes with Auto Reset, or 30 minutes without.
4. If both locations are left blank, this feature will remain active until the system is disarmed. (Door Chime may be reset using Key 9; however if a time is programmed, it cannot be reset and must time out.) When both locations are programmed "F", maximum time will be 4 hours, 15 minutes (255 minutes); or 63.75 seconds (255 quarter-seconds) for Door-Chime Duration.
5. If left blank and *Test Timer* selected, will report immediately on power-up.
6. In the State of California, do not program a time-out for fire alarms.

The Time Selector Chart on the Programming Sheet shows example times only, in seconds or minutes. In reality, any time up to those shown in the foregoing table may be programmed. Note that each of the above times is programmed in two locations. The first location has an assigned time factor of 1, the second a time factor of 16.

1st BOX	2nd BOX
tx1	tx16

Time (t):	0	1	2	3	4	5	6	7	8	9	10	11	12	13	14	15
Entry:	*	1	2	3	4	5	6	7	8	9	0	b	c	d	e	f

*Blank.

NOTE: If *both* programming locations are left blank, refer to the notes in the foregoing table for feature time-out.

To select a time up to 15 seconds, 15 minutes, 15 quarter-seconds (3.75 seconds), or 15 hours, program the respective entry into the first box only; do not program the second box. To select a time greater than 15 seconds, 15 minutes, or 15 quarter-seconds, program both boxes as follows:

1. For the feature selected, choose an appropriate time in units

shown (all seconds, minutes, or quarter-seconds -- not minutes and seconds, etc.).

2. Divide the time chosen by 16. Enter the *quotient* in the 2nd BOX and the *remainder* in the 1st BOX.
3. Check entries by adding the contents of the 1st BOX to 16 times the contents of the 2nd BOX. (Remember that a "zero" entry represents "10".)

Example 1. Program Entry Delay 1 for 1-1/2 minutes.

1. Entry Delay 1 (locations 220, 221) is in units of seconds, thus delay time is 90 seconds.
2. Divide by 16: $90/16 = 5$ (quotient) + 10 (remainder). Enter the quotient in the 2nd BOX and the remainder in the 1st BOX:

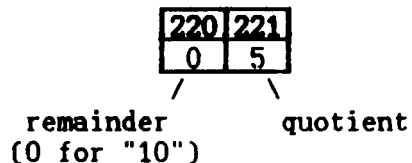

3. Check entries (remember, a "0" entry = "10"): $10 + 16(5) = 90$.

Example 2. Program the sounder to sound a Door "Chime" for 4 seconds.

1. Chime time duration (locations 230, 231) is in units of quarter-seconds, thus chime duration is 16 quarter-seconds.
2. Divide by 16: $16/16 = 1$ (quotient) + 0 (remainder). Enter the quotient in the 2nd BOX and the remainder (blank entry for "0") in the 1st BOX:

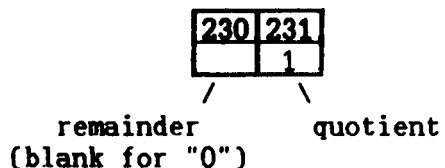

3. Check entries (remember, a blank entry = "0"): $0 + 16(1) = 16$.

Touch-Tone Dialing (Location 178)
Touch-Tone/Rotary Backup (Location 178)

Select Touch-Tone Dialing only when the subscriber has Touch-Tone service. Touch-Tone dialing is faster than rotary dialing, but

not always as reliable.

For the communicator to use Touch-Tone on all dial attempts, add a "1" to location 178. To use Touch-Tone on the first attempt with subsequent Rotary dial attempts, add a "2" to location 178. Touch-Tone Dialing will override Touch-Tone Rotary Backup if both are selected. Note that if Backup Reporting is also selected, the communicator will use Rotary dial to reach Telephone 2.

Trouble

An abnormal zone condition (a break in a normally-closed loop; a short on a normally-open loop; or either on an end-of-line-resistor supervised loop) when disarmed.

Trouble on a Burglary Zone will be indicated by a keypad sounder beep upon arming (does not apply to selective- or group-shunted zones). If auto-shunt has been removed from a Burglary Zone, that zone will go into alarm on arming. If the zone is Exit/Entry, it will go into alarm after exit-delay and entry-delay times have elapsed (if the zone is still open at that time).

Trouble (open circuit) on a Day Zone (normally closed) will be indicated by a flashing green STATUS LED and a pulsing sounder; the digital readout will display the troubled zone(s). Keypad indications are reset by Key [9].

Trouble on a Fire Zone will be indicated on the bottom red FIRE/TROUBLE LED and the sounder. An open circuit (trouble) will cause a flashing LED and a pulsing sounder after a 10-second delay. (A short circuit will cause an alarm condition: steady-on LED and pulsing sounder.) Reset Key [9] will silence the sounder the LED will go out within 30 seconds if the trouble is cleared.

Two-Digit Format See Data Format

Zone Restoral See Restoral Report

Normally, Control-Center Restoral is programmed for a zone in order to send a restoral report to the central station. The report will be sent when either the zone is repaired or the control panel is disarmed. If the restoral report is to be sent *only* when the zone is repaired, Zone Restoral should be selected (also program Control-Center Restoral). It is recommended that Auto Reset and Priority or Priority with Bypass also be selected for proper operation. See Restoral Report.

24-Hour Protection (Locations 198, 199)

A zone that provides protection at all times, whether or not the system is armed. Neither the green STATUS nor the red ARMED/ALARM LED will indicate the condition of a zone programmed for 24-Hour Protection, however an alarm condition will be recorded by Alarm History (see HOLD-DOWN FUNCTION [S]).

FOR TECHNICAL ASSISTANCE, SALES, OR REPAIRS, CALL TOLL FREE:

(800) 645-9445

IN NEW YORK:

(800) 832-5688

CHANGES FROM PREVIOUS EDITION

Summarized below are changes made to this manual since the previous edition.

- Page 5: * SPECIFICATIONS revised (Fuse F1 changed to 4A).
- Page 7: * RECOMMENDED U.L.-LISTED DEVICES revised (Smoke Detectors changed).
- Page 50: * U.L. fuse note added.
- Page 54: * Wiring Diagram revised (Fuse F1 changed to 4A).

NOTE: The material contained herein is believed to be correct and up to date at the time of printing. While every effort is made to provide accurate information, NAPCO assumes no liability for damages resulting from the misuse of this information or due to typographical or printing errors.

5. INSTALLATION

MOUNTING

Control-Panel. Choose a mounting location accessible to (a) a continuously-powered ac source, (b) a cold-water-pipe ground ideally no further away than 10 feet, and (c) telephone lines (keep telephone wiring away from speaker wires). Remove appropriate knockouts for cables. U.L. installations require that the top-right knockout be used for conduit, and that the 15 self-tapping screws (supplied with the MA-850M only) be used to secure the enclosure door closed after installation. Place the control panel at a convenient viewing height and mark the mounting holes.

Keypad. A keypad should be located near the exit/entry door. A keypad may be mounted on the MA-850 enclosure door (see below), but *not* on the MA-850M door. A backplate and junction box are available to accommodate surface and flush wall mounting. See **ORDERING INFORMATION**.

Mounting Keypad onto Enclosure Door. Use a screwdriver to remove the knockout in the front door of the MA-850 enclosure. Align the mounting holes in the keypad (see illustration) with the slots in the door and secure with #6 machine screws and nuts.

Surface Mounting onto a Wall Using the RPB-1. Secure the RPB-1 to the wall using #6 screws suitable for the wall material. (Do not overtighten the screws! Uneven walls may distort the keypad.) Pull the wires through the hole in the back of the RPB-1 or run a cable through the smaller hole in the side. (Keypad wires may have to be shortened to fit.) Raise the keypad front panel and secure the keypad to the RPB-1 with the screws provided.

Flush Mounting into a Wall Using the RPB-2. Hold the mounting box flush against the wall, with "ears" toward the wall, and mark around the outside of the box with a pencil. Carefully cut out the hole, then insert the RPB-2 and tighten its mounting screws. Raise the keypad front panel and position the keypad on the RPB-2 (only the RPB-2 may be used; other double-gang boxes may be too small). Use the two mounting holes to secure the keypad to the RPB-2 with #6 screws (see illustration).

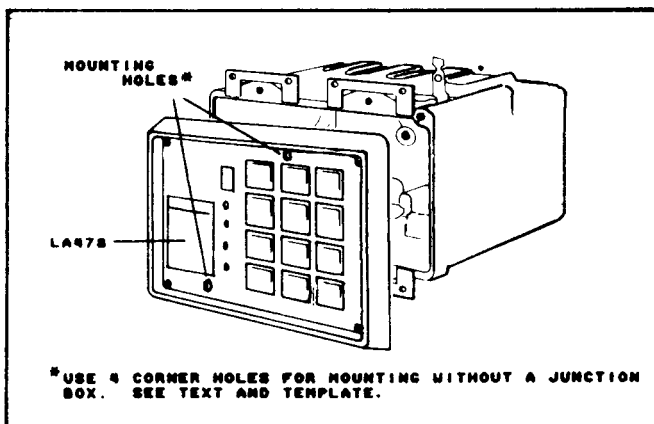

Flush Mounting Without a Mounting Box. Pin the Mounting Template (see **KEYPAD MOUNTING TEMPLATE**) to the wall or mark through the template onto the wall. Cut carefully around the lines shown (a poorly cut hole may show after mounting). Raise the front panel and secure the keypad to the wall using the four corner mounting holes (see illustration). Do not overtighten screws as uneven walls may distort keypad.

After mounting, raise the front panel and fill in the coverage for the zones listed on label LA478. Then lower the front panel and remove its protective vinyl film covering.

GROUNDING

Connect the control-center grounding screw to a metal cold-water pipe. Do *not* use a gas pipe, plastic pipe or ac ground connections. Use at least 16-gauge wire. Make the run as short and direct as possible, without any sharp bends in the wire. For U.L. installations, refer to the Grade-A Bell Wiring Diagram (see **GLOSSARY - Alarm Outputs**) for special grounding requirements.

TAMPER SWITCHES

Tamper switches may be installed to prevent opening of the control-center door or removal of the control-center cabinet from the wall. Ideally, tamper switches should be connected to a zone that is active at all times, thus it may be necessary to program that zone for 24-Hour Protection. When used on a normally-open zone, normally-closed tamper switches (normally open when set) should be wired in parallel. On a normally-closed zone, install NAPCO TPS-2 normally-open tamper switches (normally closed when set) in series.

There are two places in the cabinet to mount tamper switches:

To prevent cabinet removal; from the wall, there are three mounting holes on the left side of the cabinet; another hole on the back that allows the tamper-switch button to contact the wall.

To prevent opening the cabinet door, there are three mounting holes on the right side of the cabinet. When mounted, the tamper-switch button should contact the inside of the door. For Grade-A U.L. installations, a tamper switch *must* be used on the door (one is supplied with the MA-850M). Refer to the Grade-A Bell Wiring Diagram (see **Alarm Outputs**). Be sure to alert the user that opening the control-center door will cause a tamper alarm.

NOTE: Each NAPCO tamper switch is furnished with three machine screws for mounting, and a single self-tapping screw. The sole purpose of the self-tapping screw is to tap the holes for the

machine screws. It is then removed and may be discarded.

TYPICAL FIRE INSTALLATION

At least one smoke detector should be installed directly outside each sleeping area. If there is more than one floor, additional smoke detectors should be installed on each level, including the basement. The living-area and basement smoke detectors should be installed near the stairway of the next upper level.

For increased protection, additional detectors should be installed in areas other than those required, such as the dining room, bedrooms, utility room, furnace room, and hallways. Heat detectors, rather than smoke detectors, are recommended in kitchens, attics, and garages due to conditions that may result in false alarms and improper operation. Large areas and areas with partitions, ceiling beams, doorways, and open joists will require additional detectors.

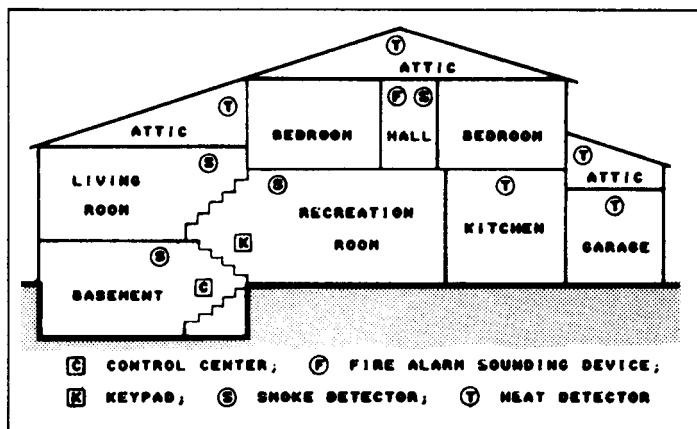

attics, and garages due to conditions that may result in false alarms and improper operation. Large areas and areas with partitions, ceiling beams, doorways, and open joists will require additional detectors.

Refer to NFPA Standard 74 (National Fire Protection Association, Batterymarch Park, Quincy, MA 02269) for additional information, including proper mounting of detectors.

TESTING THE SYSTEM

After installation is completed, test the system as follows:

1. Call the central station to inform them of the test.
2. Initiate an alarm, preferably on a zone that activates a steady siren.
3. Verify proper signalling, and call the central station to confirm their receipt of a good transmission.

KEYPAD MOUNTING TEMPLATE

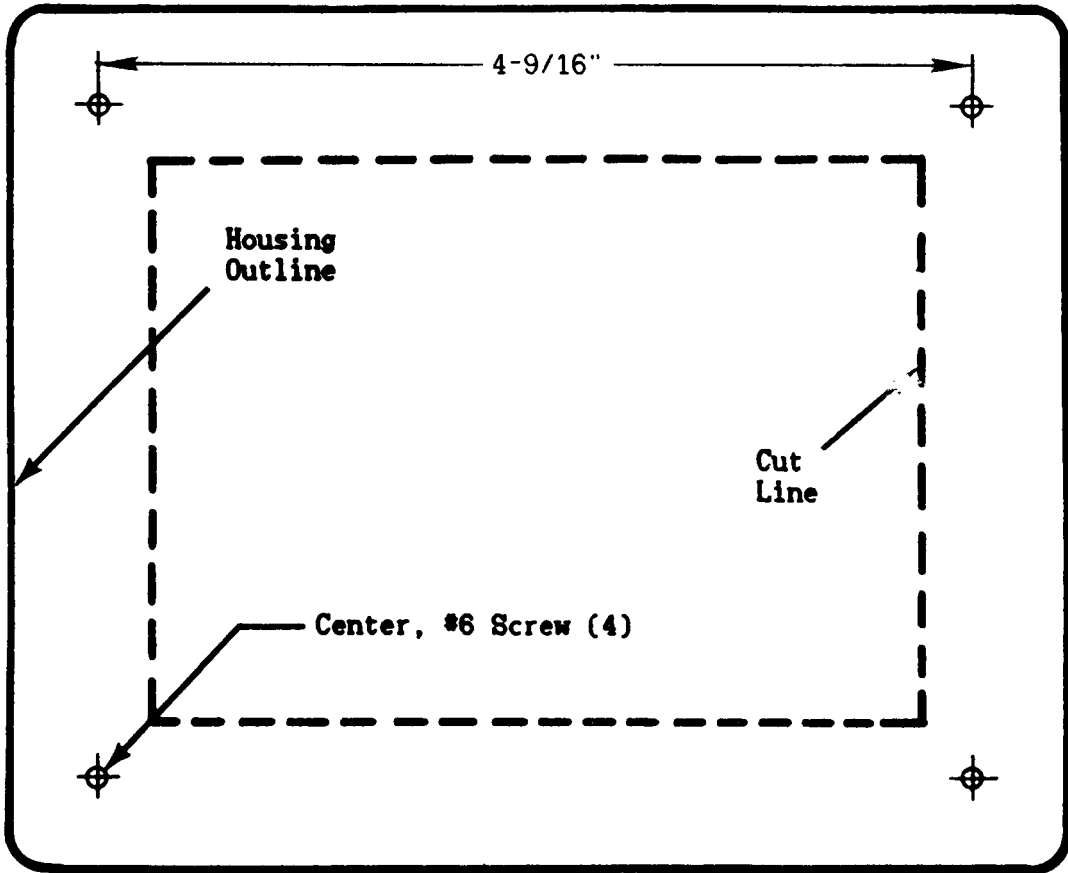

Mounting Template

NOTE: If the non-replaceable pigtail fuse (not shown) is blown, return the circuit board to NAPCO for repair. To comply with U.L. requirements, this fuse may not be serviced in the field.

INSTRUCTIONS: Should removal of the circuit board be necessary, use this wiring legend to relocate leads to their proper terminals. Enter wire identification number or color code in WIRE NUMBER column; enter wire function in DESCRIPTION column (optional).

TERMINAL NUMBER	WIRE NUMBER	DESCRIPTION
1		
2		
3		
4		
5		
6		
7		
8		
9		
10		
11		
12		
13		
14		
15		
16		
17		
18		
19		
20		
21		
22		
23		
24		
25		
26		
27		
28		
29		
30		
31		
32		
33		
34		
35		

NOTES _____

INDEX

Abort Delay	19	Disable Bell Test	28
also see Time Selection	41-43	Disable Call Waiting	28
Ac-Failure		Disable Fault Find	28
Indication	10, 13	Disable Swinger Shutdown	28
Reporting	19	Display Shunt (Key [2])	11
Access Number for Outside Line	19	Display Status (Key [3])	11
Alarm Codes, see Report on Alarm	36	Door Chime (Key [5])	11, 29
Alarm History (Key [S])	11, 20	also see Time Selection	41-43
Alarm Outputs	3, 20-21	Double Reporting	29
also see Time Selection	41-43	also see Backup Reporting	24
Alarm Power, see Relay Output	21	and Split Reporting	38
Alarm Reset	13	"E" Lugs	29
Alarm Time-Out, see Time-Out	41	Easy Arming, see Ambush Code	22
Ambush Code	22	Enable Communicator-Confidence Test	30
Ambush Zone	13	Enable Keypad Panic, see Panic Zone	33
Anti-Jam Time	23	Enable Zone 8 as Fire Zone,	
Arm Lug (E4)	23	see Fire Zone	31
Arm/Disarm Codes,		Entry Delay	30
see Personal Codes	12-13	also see Time Selection	41-43
Arm-Only Code, see Ambush Code	22	Exit Delay	30
Arming/Disarming	13	also see Time Selection	41-42
LED (ARMED/ALARM)	10	Exit/Entry Follower	30
Arming Without Ac	10	Extended Format, see Data Format	26
Audible Test on Arming	23	Fallback Code	13, 31
Auto-Reset	23	Fault Find (Key [7])	11, 14
Auto-Shunt Zone,		Features	3-4
see Remove Auto-Shunt	36	Fire	
Backup Reporting	24	Installation, Typical	48
also see Double Reporting	29	LED (FIRE/TROUBLE)	10
Battery	24	Lug (E9)	31
Burglary Lug (E10)	24	Zone	31
Burglary Output, see Alarm Outputs	20	also see Time Selection	42
CC403 Telephone Cord	12	Glossary	15, 19-45
Call Waiting,		Grade-A Bell,	
see Disable Call Waiting	28	see Speaker/Bell Output	21
Closing Codes,		Ground-Start Module, GSM-400	
see Closing Report	24-25, 27	(Lug E3)	31-32
Closing Report	24-25, 27	Grounding	47
Come Up Armed After Power Failure	25	also see Grade-A Bell wiring	21
Communicator-Confidence Test		Group Shunt	32
(Key [6])	11, 14, 30	Hold-Down Functions	2, 10-11
Conditional-Closing Report	24	Installation	46-50
Conditional-Closing/Status Report	24	Installation Record	16
Conditional-Opening Report,		Instant Protection (Key [4])	11
see Opening Report After Alarm	33	Jumpers, see Alarm Outputs	20-21
Control-Center Restoral Report,		Keypad,	9-14; 46-47
see Restoral, Control Center	37	Controls & Indicators	9-11
Data Format	25-27	Functions	2, 3, 9-11
also see Programming Sheet	18	Mounting	46-47; 49
Day Zone	27	Operation	12-14
Dial Delay, see Pre-Dial Delay	34	Keypad Panic,	14
Dial-Tone Detection	28	also see Panic Zone	33-34
Digital Readout	3, 10	and Fire Zone	31

Keypad Timer Offset, see Test-Timer Offset	40-41	Display (Key [2])	11
Line-Reversal Module, M278	32	Group	32
Listen-In Module (Lug E5)	32	LED (SHUNT)	10
Loop Response	32-33	Selective	38
Low Battery (Lug E11)	33	Zone-Select (Key [S])	9
Mini-Sounder, see Sounder	3, 9	Single-Digit Event Code Format, see Data Format	26
Mounting	46-47; 49	Smoke Detectors	38
No Ac, see Ac-Failure Reporting	19	Sounder	3, 9
Opening Codes, see Opening Report	33	Speaker/Bell Output	21
Opening Report	33	Specifications	5
Opening Report After Alarm	33	Split Reporting	38
Ordering Information	6	also see Double Reporting	29
Outputs, see Alarm Outputs	20-22	Status (Key [3])	11
Panic Alarm, see Keypad Panic	14	LED (STATUS)	10
Panic Zone	33-34	Subscriber Identification Numbers	39
Panic Buttons	9, 14, 34	Subscriber PROM	2, 15-16
Personal Codes	12-13	also see Anti-Jam Time	23
Power-Up Sequence	12	Sum-Check Format, see Data Format	27
Pre-Dial Delay	34	Supervisory Zone, see Fire Zone	31
Priority Zone	34	Swinger Shutdown, see Disable Swinger Shutdown	28
Priority Zone with Bypass	35	Tamper Switches	21, 47
Program (Key [8])	11, 12-13, 35	Tamper Zone, see Speaker/Bell Output	21, 22
also see Keypad Timer Offset	41	Telephone Numbers	39-40
Program Code	11, 12-13, 35	also see Disable Call Waiting	28
also see Keypad Timer Offset	41	Test (Key [1])	10
Programming	15	also see Audible Test on Arming	23
Materials	15	Test Timer	40
Notes, see Programming Sheets	17-18	Test-Timer Offset	40-41
Record Sheets	17-18	Testing the System	48
Steps	15	Time-Out	41
Pulsing Alarm Output, see Alarm Outputs	20	Time Selection	41-43
Receiver Format	35	also see Programming Sheet	17
also see Programming Sheet	18	Touch-Tone Dialing	43-44
Relay Output, see Alarm Outputs	21	Touch Tone/Rotary Backup	43-44
also see Time Selection	42	Trouble	44
Relay Control (Lug E12)	36	Two-Digit Event Code Format, see Data Format	26-27
Remove Auto-Shunt	36	U.L.	
Report on Alarm	36	Classifications	8
Reset (Key [9])	11	Listed Devices	6, 7
Reset, Alarm	13	Requirements, Summary of	8
Reset Output-Relay Devices	36	Unconditional Closing Report, see Closing Report	24-25
also see Alarm Outputs	20	User Codes, see Personal Codes	12-13
Reset Test Timer on Report, see Test Timer	40	Wiring Diagram	54
Restoral Report	35-36	also see Grade-A Bell wiring	21
Restore Codes, see Restoral Report	37	Zone Restoral	44
RJ31X Telephone Jack	12	also see Restoral Report	37
Select User(s) Closing, see Closing Report	24-25	Zone 8, see Fire Zone	31
Select User(s) Opening, see Opening Report	33		
Selective Shunt	38	10-15, How to Program	16
Shunt,		24-Hour Protection	45

NAPCO LIMITED WARRANTY

NAPCO SECURITY SYSTEMS, INC. (NAPCO) warrants each of its products to be free from manufacturing defects in materials and workmanship for fifteen months following the date of manufacture. NAPCO will, within said period, at its option, repair or replace any product failing to operate correctly, without charge to the original purchaser or user.

This warranty shall not apply to any equipment or any part thereof which has been repaired by others, improperly installed, improperly used, abused, altered, damaged, subjected to accident, nuisance, flood, fire or acts of God, or on which any serial numbers have been altered, defaced or removed. Seller will not be responsible for any dismantling, reassembly or reinstallation charges.

In order to exercise the warranty, the product must be returned by the user or purchaser, shipping costs prepaid, and insured to NAPCO. After repair or replacement, NAPCO assumes the cost of returning products under warranty.

There are no warranties, express or implied which extend beyond the description of the face hereof. There is no express or implied warranty of merchantability or a warranty of fitness for a particular purpose. Additionally, this warranty is in lieu of all other obligations or liabilities on the part of NAPCO.

This warranty contains the entire warranty. It is the sole warranty and any prior agreements or representations, whether oral or written,

are either merged herein or are expressly cancelled. NAPCO neither assumes, nor authorizes any other person purporting to act on its behalf to modify, to change, nor to assume for it, any other warranty or liability concerning its products.

In no event shall NAPCO be liable for an amount in excess of NAPCO's original selling price of the product, for any commercial loss or damage, whether direct, indirect, incidental, consequential, or otherwise arising out of any failure of the product. Seller's warranty, as hereinabove set forth, shall not be enlarged, diminished or affected by and no obligation or liability shall arise or grow out of Seller's rendering of technical advice or service in connection with Buyer's order of the goods furnished hereunder.

NAPCO recommends that the entire system be completely tested weekly.

Warning: Despite frequent testing, and due to, but not limited to, any or all of the following; criminal tampering, electrical or communications disruption, it is possible for the system to fail to perform as expected. Therefore, the consumer is advised to take any and all precautions for his or her safety including, but not limited to, fleeing the premises and calling police or fire department, in order to mitigate the possibilities of harm and/or damage.

This warranty shall be construed in accordance with the laws of the State of New York.

MAGNUM ALERT 850/850M

WIRING DIAGRAM

NAPCO SECURITY SYSTEMS, INC
AMITYVILLE, N.Y. 11701



IMPORTANT

Shorting fuses to either the case or to each other may cause damage to the circuit board. Always use fuse pullers.

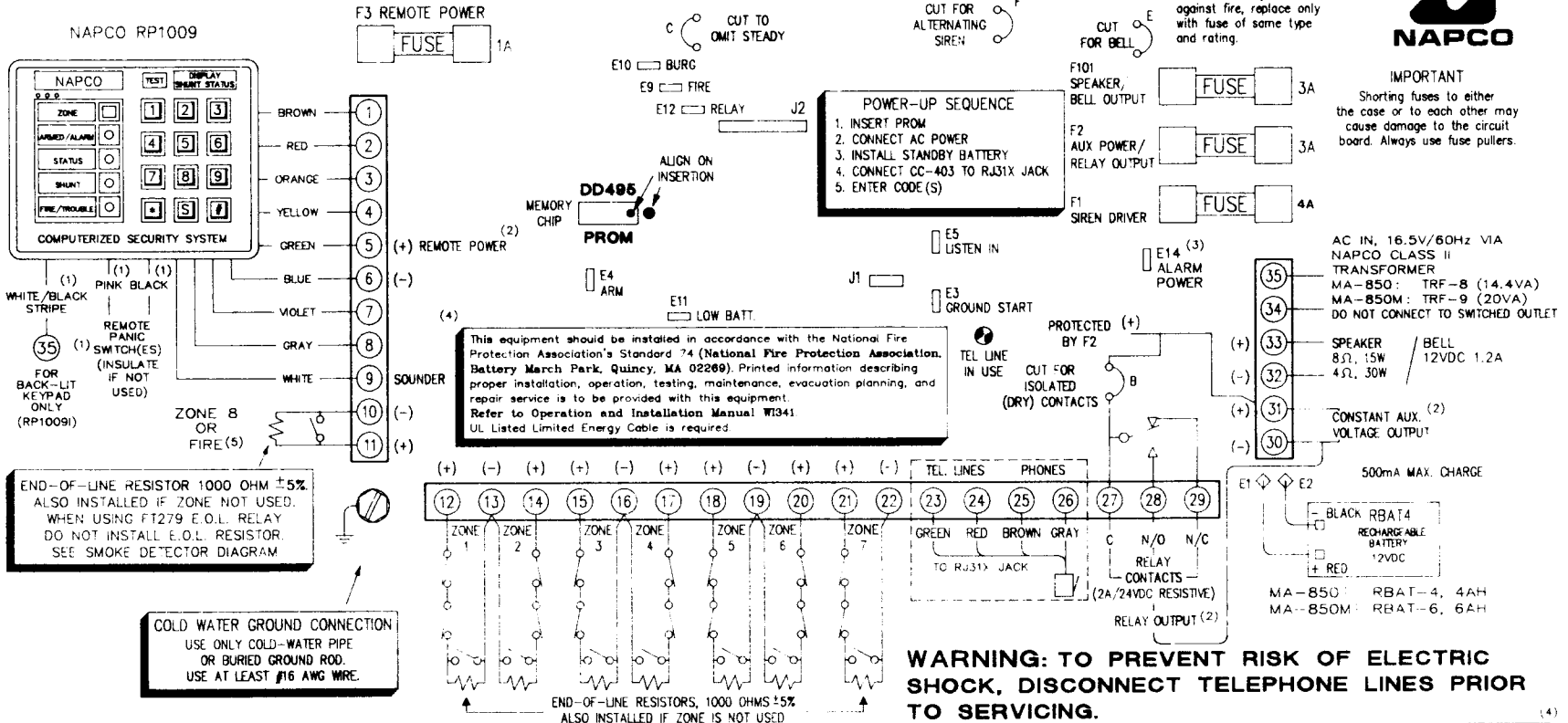

1. REMOTE PANIC WIRING NOT IN EARLY RP1009 KEYPADS. IN ADDITION, IN EARLY RP1009I KEYPADS, WIRE FOR BACKLIGHTING IS BLACK.
2. COMBINED STANDBY OUTPUTS:
AUX. POWER, REMOTE POWER, RELAY OUTPUT (STANDBY OR ALARM)
MA-850: 250mA WITH STANDARD TRF-8 AND RBAT-4
400mA WITH OPTIONAL TRF-9 AND RBAT-6
MA-850M: 400mA WITH STANDARD TRF-9 AND RBAT-6
3. FOR 1.0A RELAY OUTPUT IN ALARM, SEE INSTRUCTIONS.
4. U.L. LISTING FOR FIRE REFERS TO MA-850 (RESIDENTIAL) UNITS ONLY
5. UNLESS PROHIBITED BY LOCAL CODES.

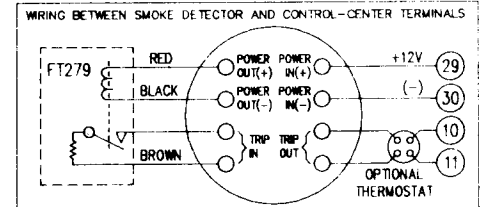



MA850: HOUSEHOLD FIRE & BURGLARY WARNING SYSTEM CONTROL UNIT

MA850M: BURGLAR ALARM SYSTEM CONTROL UNIT (GRADE A LOCAL; GRADE B CENTRAL STATION; GRADE A POLICE CONNECT)

© 1988 NAPCO

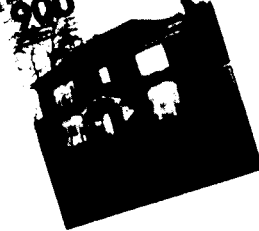
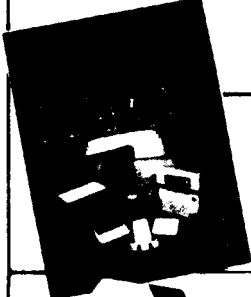
Sales aids prepared by Napco help you move more products and earn more profits. Order now to start putting this carefully researched material to work for you. Fill out this order form (both sides) and mail it with your check or money order payable to Napco. Or call Napco today for the name of your nearest stocking distributor. (See reverse side for toll-free numbers and address.)

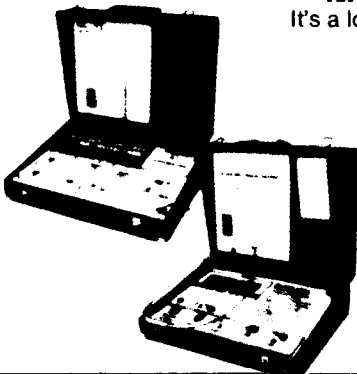
		QUANTITY	AMOUNT	
    	<p>NAPCO CUSTOMER LITERATURE Full-color folders in easily understandable language. Show how each system protects the customer's home or business. Ideal for sales presentations, mailers, etc. Priced \$9.00 per 100 (Sold in lots of 100)</p> <p>Magnum Alert-700 Security System (A177) <input type="checkbox"/></p> <p>Magnum Alert-800 Security System (A166) <input type="checkbox"/></p> <p>Magnum Alert-825 Security System Residential (A218) <input type="checkbox"/></p> <p>Commercial (A218 COM) <input type="checkbox"/></p> <p>Magnum Alert-850 Security System Residential (A221) <input type="checkbox"/></p> <p>Commercial (A221 COM) <input type="checkbox"/></p> <p>in French, Residential (A239) <input type="checkbox"/></p> <p>in French, Commercial (A239 COM) <input type="checkbox"/></p> <p>Magnum Alert-854 Security System Residential (A245) <input type="checkbox"/></p> <p>Commercial (A245 COM) <input type="checkbox"/></p> <p>Magnum Alert-900 Security System Residential (A191) <input type="checkbox"/></p> <p>Commercial (A191 COM) <input type="checkbox"/></p> <p>Shock Guard (A186) <input type="checkbox"/></p>			
	<p>NAPCO PROPOSAL FOLDER Pocketed folder for literature, technical sheets and proposals. Helps you wrap up sales with a professional look. Literature Folder (A176) .75 each <input type="checkbox"/></p>			
	<p>NAPCO SALES & TECHNICAL GUIDE Binder contains: Sales literature; Working instructions for all products; Engineering updates and Memos; Troubleshooting guides. You are placed on a select mailing list to receive all future updates. Binder (A173) \$24.95 each <input type="checkbox"/></p>			
	<p>NAPCO BRIEFCASE DEMONSTRATORS It's a lot easier to close sales by demonstrating the system right at your customer's premises.</p> <p>Magnum Alert-800 Demonstrator Case (SDC/800) \$299.95 each <input type="checkbox"/></p> <p>Magnum Alert-825 Demonstrator Case (SDC/825) \$299.95 each <input type="checkbox"/></p> <p>Magnum Alert-850 Demonstrator Case (SDC.850A) \$249.95 each <input type="checkbox"/></p> <p>(Add \$2.50 for freight)</p>			
	TOTAL			

I'd like to preview your Consumer Literature first. Please send a free copy of the item(s) checked below:

- | | |
|-----------------------------------------------------------|-----------------------------------------------------------|
| <input type="checkbox"/> Magnum Alert-700 Security System | <input type="checkbox"/> Magnum Alert-854 Security System |
| <input type="checkbox"/> Magnum Alert-800 Security System | <input type="checkbox"/> Magnum Alert-900 Security System |
| <input type="checkbox"/> Magnum Alert-825 Security System | <input type="checkbox"/> Shock Guard |
| <input type="checkbox"/> Magnum Alert-850 Security System | <input type="checkbox"/> Napco Proposal Folder |

Enclosed is my check/money order for \$ _____ to cover the Napco sales aids ordered on the reverse side.

NAME _____

TITLE _____

COMPANY _____

ADDRESS _____

CITY _____ STATE _____ ZIP _____

TELEPHONE _____



SALES DEPARTMENT
NAPCO SECURITY SYSTEMS, INC.
333 Bayview Avenue, Amityville, NY 11701
(800) 645-9445 (USA) (800) 832-5688 (NY) (800) 247-4047 (CAN) Telex 510-227-9854

PLACE
STAMP
HERE

SALES DEPARTMENT
NAPCO SECURITY SYSTEMS, INC.
333 Bayview Avenue
Amityville, New York 11701

**SEND NOW FOR
YOUR NAPCO
BUSINESS
BUILDERS**